

SIGSAUER[®]
NEVER SETTLE



CATALOG



EVOLUTION OF SIG	2
FROM WAGONS TO WORLDWIDE LEADER	3
U.S. DEFENSE CONTRACTS	4
INDUSTRY AND CONSUMER AWARDS	5
PISTOLS	6
LEGION SERIES	38
CUSTOM WORKS	42
RIFLES	50
AMMUNITION	68
ELECTRO-OPTICS	90
SUPPRESSORS	152
AIRGUNS	162
ACADEMY	184
TEAM SIG	190
ACCESSORIES	192
SPECIFICATIONS	198

CONTENTS

SIG SAUER
NEVER SETTLE

SIG SAUER®, Inc. • 72 Pease Boulevard • Newington, NH 03801 USA • +1 (603) 610-3000

An ISO 9001:2015 Registered Company. Manufacturing in the U.S.A.

All trademarks, service marks, trade names, trade dress, product names and logos appearing in this catalog are the property of their respective owners.
No trademark or service mark appearing in this catalog may be used without the prior written consent of the owner.

THE EVOLUTION OF SIG SAUER®



In our state-of-the-art facilities across ten locations worldwide SIG SAUER® manufactures the finest firearms, electro-optics, ammunition, suppressors, and airguns, while also offering world-class firearms and tactical training at the SIG SAUER AcademySM.

At SIG SAUER we are driven by our relentless pursuit to manufacture products of unparalleled quality, an unwillingness to compromise, and an absolute refusal to settle. We are emboldened by our love of freedom and share the same passion and pride for our country as those who choose the SIG SAUER brand.

Regardless of whether a SIG SAUER product is being deployed on the battlefield by a soldier, protecting law enforcement as an official duty sidearm, or simply the product of choice of a private citizen, you can trust that if it carries the SIG SAUER name it is built to our precise exacting standards, and undergoes the same rigorous quality controls to ensure that it performs when it matters most.

FROM WAGONS TO WORLDWIDE LEADER

When business entrepreneurs Friedrich Peyer Im Hof, Heinrich Moser, and Conrad Neher opened a wagon factory near the Rhine Falls in Switzerland in 1853, they laid the foundation for what would become the international leader in the small arms industry. Just seven years after constructing an industrial plant for building their wagons and railway cars, the three ambitious owners undertook a new venture responding to a challenge from Switzerland's Federal Ministry of Defense to develop a state-of-the-art rifle in hopes that the Swiss Army would adopt it.

Four years later, the trio found themselves facing an order for 30,000 of their rifles, and changed the name of their company to Swiss Industrial Group. The name was later shortened to SIG as they officially became one of the world's premier firearms manufacturers.

In the 1970's, the SIG small arms division expanded within Europe to include Hammerli Target Arms of Switzerland, and the legendary J.P. Sauer & Sohn, GmbH of Germany - one of Europe's oldest and most prestigious firearms manufacturers.

In the 1980's, SIG set its sights on the United States of America and opened its first American location in Virginia under the name SIGARMS®, and began importing and assembling the company's classic handguns.

In the 1990's, SIGARMS expanded its United States footprint by opening new manufacturing facilities in Exeter, New Hampshire where it would continue to expand to include the world-class SIGARMS training academy in Epping, New Hampshire.

In 2007, SIGARMS officially changed its name to SIG SAUER, aligning the company under a single global brand. Since then SIG SAUER has experienced unprecedented growth and expanded its New Hampshire footprint to include a 206,000 sq./ft. corporate headquarters and advanced manufacturing facility at Pease International Tradeport.

SIG SAUER continually invests in workforce development by hiring the foremost industry experts in ever expanding categories to ensure that all SIG SAUER products exceed the quality expectations that are synonymous with the brand.

Today, the SIG SAUER product lineup goes well beyond firearms to include a broad array of products such as electro-optics, ammunition, suppressors, and airguns, all designed, engineered, and manufactured to the same exacting standards of quality, reliability, and performance that have made SIG SAUER the brand of choice for the military, special forces, law enforcement, and civilians across the globe. In addition, SIG SAUER has expanded its U.S operations with a dedicated optics facility in Oregon and a purpose-built ammunition plant in Arkansas.

SIG SAUER has evolved because we continually compete against ourselves, because we believe our greatest success has yet to be engineered, and we are driven by the knowledge that our customers can't afford to settle so they trust we never will. SIG SAUER. Never Settle.



U.S. DEFENSE CONTRACTS

U.S. MILITARY (ALL BRANCHES) M17*/M18*

After one of the most rigorous and highly competitive selection processes in the history of small arms, the SIG SAUER® P320* based M17 and M18 were awarded the Modular Handgun System (MHS) contract by the U.S. Army. The M17 and M18 have now been adopted by all branches of the U.S. Military.

U.S. ARMY NEXT GENERATION SQUAD WEAPONS (NGSW) PROGRAM

SIG SAUER has been selected by the U.S. Army to develop the Next Generation of squad-based weapon systems, including a lightweight machine gun, a carbine rifle, a next generation of suppressor and the first-of-its-kind hybrid ammunition.

U.S. ARMY CONTRACTING COMMAND .300 WIN MAG AMMUNITION

SIG SAUER Ammunition, known for quality and accuracy, was selected by the U.S. Army to manufacture the Mk 248 MOD 1 and MOD 0 300 Win Mag ammunition for use in U.S. Military Sniper Platforms.

DOD SUPPRESSED UPPER RECEIVER GROUP MCX™ (SURG)

The SIG SAUER MCX system was selected to upgrade the existing M4A1 U.S. Special Operations Forces carbines and optimize their weapons for continuous suppressed use on the battlefield.

U.S. ARMY/DOD/U.S. AIR FORCE TANGO6T

The SIG SAUER Electro-Optics TANGO6T has three times been selected by the Department of Defense as the U.S. Army Squad Designated Marksman Rifle (SDMR), the USSOCOM Squad-Variable Powered Scope (S-VPS), and the Direct View Optic (DVO).

DEPARTMENT OF HOMELAND SECURITY (DHS) P320 & ROMEO1PRO

SIG SAUER Electro-Optics ROMEO1Pro miniature open reflex sight was chosen by the Department of Homeland Security for U.S. Immigration and Customs Enforcement (ICE) as the official red dot optic for their SIG SAUER P320 official duty pistol.

U.S. COAST GUARD PROFORCE® P229*

SIG AIR® was chosen to supply the U.S. Coast Guard with the SIG AIR PROFORCE P229 airsoft pistol as an official training pistol for Cadets and Guardsmen.



M17



NEXT GEN



TANGO6T™



.300 WIN MAG

INDUSTRY AND CONSUMER AWARDS

SIG SAUER® is proud to be honored by our peers and have our products recognized for innovation, quality, and capability.

2020 TACTICAL RETAILER GOLD LEVEL CHOICE AWARDS

Recognized by readers as the best in the industry by tactical retailers across the industry.

Favorite New Products:

- Romeo1PRO
- AR Pistol



2020 SHOOTING SPORTS RETAILER GOLD LEVEL CHOICE AWARDS

Recognized by readers as the best in the industry by shooting sports retailers across the industry.



- Handgun Manufacturer
- AR Pistol

2020 INDUSTRY CHOICE AWARDS

Recognizing fit, form, finish, and functionality in firearms by industry peers.

- Innovation of the Year:** CROSS Bolt-Action Rifle
- Handgun of the Year:** P320 XFIVE LEGION



2020 OUTDOOR LIFE AWARDS

Recognizing versatility in riflescopes.

- Best New Rifle:** CROSS Bolt-Action Rifle
- Best New Spotting Scope:** OSCAR8



2019 BALLISTICS BEST READERS'S CHOICE AWARDS:

The Ballistic Best Reader's Choice Awards from Athlon Outdoors gives consumers the ability to vote for recognition of superiority in class, quality, and innovation across various product categories.

- Best Semi-Auto Rifle:** M400 TREAD
- Best Compact Semi-Auto:** P320 XCOMPACT



2020 BALLISTICS BEST READERS'S CHOICE AWARD:

- Best AR-10 Rifle** 716i TREAD

2020 NASGW-POMA CALIBER AWARD

Recognizing new and innovative products within the sporting goods industry.



- Best New Optic:** ROMEOZero



PISTOLS



PISTOLS

Choose from a full array of sizes, triggers, calibers, finishes, and features—all with unfailing SIG reliability and accuracy.

INSPIRED BY THE ELITE PROFESSIONAL. CARRIED BY ALL WHO DEMAND THE BEST.

Unless it's a SIG, a handgun is just a handgun. Engineered to perform anywhere, at any time, and under any circumstance, SIG pistols boast unique, advanced features that stand out amongst the rest. Key features include:



X-RAY3™ Sights



Integral Accessory Rail



4-Point Safety System



NITRON™ Stainless Steel Slide



SAS® (SIG ANTI-SNAG) FT Bullseye Sight



Threaded Barrel



Rear Sight Plate



ROMEOIPRO™ Reflex Sight

SIZING UP YOUR SITUATION

You want a pistol with frame dimensions directly suited to your needs. Whether you'll be sliding your handgun into a range bag, concealing it in a purse, shooting competitively, or defending your home, SIG SAUER® offers a pistol for every shooter.



FULL-SIZE

When shootability and sighted accuracy are a must. Generous dimensions and even weight distribution help to deliver a more accurate sight picture and reduced felt recoil.

Barrel > 4" Frame > 7.5 x 5.5"



CARRY

A balance of shootability with concealment. A full-size grip allows the shooter more control while reduced slide length offers lighter carry.

Barrel < 4" Frame 7 x 5.5"



COMPACT

If concealment is an essential requirement, the reduced slide length and grip height enable easy concealment and carry, with ergonomics designed to promote point-and-shoot accuracy.

Barrel < 4" Frame ≈ 7 x 5"



MICRO-COMPACT

Discreet, lightweight, and able to fit almost anywhere. Often called "pocket pistols," the SIG micro-compact delivers the ultimate in concealment.

Barrel < 3.5" Frame < 5.8 x 4.3"

TRIGGER TIME

Any expert will tell you, it's the trigger that ultimately puts rounds on target. Weigh the pros and cons of each trigger carefully to select the one you can fire accurately, and carry with confidence.

STRIKER-FIRED TRIGGER

STR | Short Tactile Reset

Every trigger pull has the same weight and feel with a quick tactile reset to ensure faster and more consistent shots.

HAMMER-FIRED TRIGGER

DA/SA | Double-Action/Single-Action

The first trigger pull performs the double-action of cocking the hammer and then releasing the sear. Followed by lighter, single-action trigger pulls on all subsequent shots. The heavier first trigger pull acts to reduce inadvertent discharges.

SAO | Single-Action-Only

The trigger performs the single-action of releasing the hammer with a consistent trigger pull that is generally regarded as the shortest, lightest, and smoothest available. The slide can still be operated with the safety engaged (a SIG exclusive on P220®, P226®, P229®, P238®, and P938® models). All models feature a manual thumb safety.

THE CALIBER DEBATE

Popular opinions vary widely, but only you can select the right caliber for you. Consider bullet weight and velocity, your desired magazine capacity, ammunition cost, and availability.



.45AUTO

Known for a combination of power and controlled penetration due to a large diameter bullet and moderate velocities.



10MM

Offers higher velocity, greater range, and more kinetic energy than the .45AUTO.



.40S&W

Designed to match the performance of the FBI's reduced-velocity 10mm, in a smaller cartridge size, while offering an energy advantage over the 9mm.



.357SIG

Developed in 1994 to duplicate the performance of a 125 gr .357 Magnum cartridge. The .357SIG combines relatively high velocity with remarkably flat trajectory.



9MM

Regarded as the world's most popular and widely used handgun cartridge combining a flat trajectory with relatively low felt-recoil.



.380ACP

Compact and light design make it popular in handguns designed for concealed carry. Less powerful than larger calibers minimizing recoil and improving controllability.

RED DOT REVOLUTION



As the only manufacturer in the industry that can truly integrate a firearm and an optic into a single system that's ready to shoot, right out of the box, SIG SAUER® is leading a Red Dot Revolution that transforms the way you shoot. SIG SAUER now offers virtually all of our most popular pistols with the option of a factory-installed, and zeroed, reflex optic. Greater performance, increased accuracy, and radically simple – welcome to the Red Dot Revolution.

WHY PISTOL MOUNTED OPTICS?

Designed for fast, responsive target acquisition and accuracy, open reflex red dot sights, or pistol-mounted optics, are quickly becoming popular among experienced and novice shooters. Red dot sights allow you to quickly and easily acquire your sight picture and make follow-up shots faster. The inherent simplicity of a single aiming point on the same visual plane as the target, makes red dots extremely easy to use, simply put the dot on the target, and press the trigger.



1911 RXZ

P320-M17

P226* SAO

P320* X-FIVE* LEGION*

P320 XCOMPACT

P365XL™

P365



MICROCOMPACT SIZE WITH FULL-SIZE CAPACITY

The award-winning P365 has redefined the micro-compact pistol category, quickly becoming one of the most coveted firearms in the industry. The P365 features a patented modified double-stack magazine capable of 10+1, 12+1 or 15+1 full-size capacity. Its ergonomic design makes it more shootable than the typical pocket-sized pistols with a clean, crisp trigger pull you expect from a SIG SAUER®. The P365XL™ ROMEOZero™ is available with the ROMEOZero reflex optic installed and zeroed right out of the box, making it the most capable micro-compact available today.

9mm

SHARED FEATURES

- ▲ NITRON® stainless steel slide
- ▲ Tritium night sights
- ▲ Includes (1) 10rd flush fit and (1) 10rd extended magazine (365 NITRON & SAS®), (2) 12rd magazines (XL & XL ROMEOZero)
- ▲ Polymer grip



XSERIES XL ROMEOZERO

- ▲ NITRON® stainless steel slide with ROMEOZero™ installed
- ▲ XSERIES flat trigger
- ▲ XSERIES grip module



XL

- ▲ NITRON stainless steel slide compatible with ROMEOZero
- ▲ XSERIES flat trigger
- ▲ X-RAY3™ day/night sights



SAS®

- ▲ NITRON stainless steel slide with SAS treatment
- ▲ Flush-fit FT Bullseye sight
- ▲ Flush slide catch and take down lever



NITRON

- ▲ NITRON stainless steel slide
- ▲ X-RAY3™ day/night sights
- ▲ Available with manual safety



ROMEOZERO INSTALLED (XL ROMEOZERO)



OPTIONAL MANUAL SAFETY (XL, NITRON)



FLUSH-FIT FT BULLSEYE SIGHT (SAS)

STATE COMPLIANT MODELS AVAILABLE

365XL-9-BXR3-RXZ-10 / 365XL-9-BXR3-10 / 365XL-9-BXR3-MS-10 / 365-9-BXR3-MS-MA

P365	SKU	Caliber	Magazine Capacity	Length (in)	Height (in)	Width (in)	Barrel Length (in)	Sight Radius (in)	Weight w/Mag (oz)	Sights	Grip Type	Slide Material	Slide Finish	Trigger Action
XL ROMEOZERO	365XL-9-BXR3-RXZ	9mm	12	6.6	5.5	1.1	3.7	5.6	20.7	ROMEOZero X-RAY3™ Day/Night Front Sight	Polymer	Stainless	NITRON	Striker
XL	365XL-9-BXR3 / 365XL-9-BXR3-MS	9mm	12	6.6	4.8	1.1	3.7	5.6	20.7	X-RAY 3 Day/Night Sights	Polymer	Stainless	NITRON	Striker
SAS	365-9-SAS	9mm	10	5.8	4.1	1.0	3.1	N/A	17.8	Flush-Fit FT Bullseye	Polymer	Stainless	NITRON	Striker
NITRON	365-9-BXR3 / 365-9-BXR3-MS	9mm	10	5.8	4.3	1.0	3.1	4.9	17.8	X-RAY 3 Day/Night Sights	Polymer	Stainless	NITRON	Striker

P320[®]

MODULAR HANDGUN

A clean, crisp, short trigger reset with safe takedown and unprecedented modularity delivering elite performance for all.

CHOOSE A CALIBER:

The P320 is available in a variety of popular calibers.



CHOOSE GRIP FIT:

Interchangeable grip modules provide optimal grip circumference and access to controls without adding a bulky backstrap.

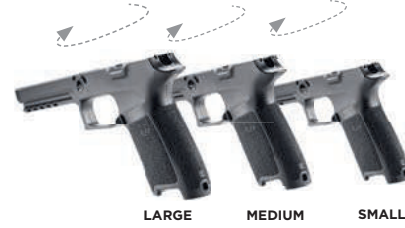

OPTIONAL X-CHANGE KITS

The modular pistol has arrived. Removing P320's fire control group unlocks hundreds of combinations.



CHOOSE STYLE AND A SIZE:

Provides the modularity to switch between multiple sizes, and between the standard and XGRIP.

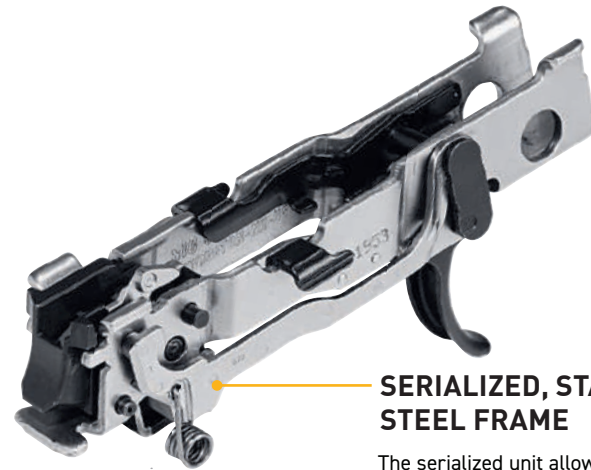

SERIALIZED, STAINLESS STEEL FRAME

The serialized unit allows the user to change everything from size, to caliber, to grip at will.



3-POINT TAKEDOWN NO TRIGGER PULL OR TOOLS REQUIRED:

1. Remove magazine
2. Lock slide to the rear
3. Rotate takedown lever

ADDITIONAL SAFETY FEATURES:

- Striker Safety
- Disconnect Safety

THE WORLD'S MOST INNOVATIVE HANDGUN

With its unmatched modularity, unprecedented accuracy, and uncompromising reliability, the state-of-the-art SIG SAUER[®] P320 has quickly become one of the most sought after firearms on the market today. Chosen by all branches of the U.S. military, as well as law enforcement agencies across the country and around the world, the P320 redefines the modern handgun.

9mm

SHARED FEATURES

- ▲ NITRON[®] stainless steel slide
- ▲ Modular striker-fired pistol
- ▲ Contrast sights
- ▲ 1913 rail
- ▲ Front cocking serrations
- ▲ Polymer grip



SMOOTH CONSISTENT TRIGGER PULL



INTERCHANGEABLE GRIP MODULES



STEEL CONTRAST SIGHTS



FULL-SIZE

- ▲ NITRON[®] stainless steel slide
- ▲ Contrast sights
- ▲ 4.7" barrel



COMPACT

- ▲ NITRON stainless steel slide
- ▲ SIGLITE[®] night sights or contrast sights
- ▲ 3.9" barrel

P320 ONE FOR ALL

A CLEAN, CRISP, SHORT TRIGGER RESET, SAFE TAKEDOWN AND UNPRECEDENTED MODULARITY, DELIVER ELITE PERFORMANCE FOR ALL.

P320	SKU	Caliber	Magazine Capacity	Length (in)	Height (in)	Width (in)	Barrel Length (in)	Sight Radius (in)	Weight w/Mag (oz)	Sights	Grip Type	Slide Material	Slide Finish	Trigger Action
FULL-SIZE	320F-9-B	9mm	17	8.0	5.5	1.3	4.7	6.6	29.5	Contrast	Polymer	Stainless	NITRON	Striker
COMPACT	320C-9-B/ 320C-45-BSS	9mm / 45 AUTO	15 / 9	7.2	5.3	1.3	3.9	5.8	25.8	SIGLITE / Contrast	Polymer	Stainless	NITRON	Striker
COMPACT-MS	320C-9-BSS-MS-MA	9mm	10	7.2	5.3	1.6	3.9	5.8	25.8	SIGLITE Night Sights	Polymer	Stainless	NITRON	Striker

STATE COMPLIANT MODELS AVAILABLE

320F-9-B-10 / 320C-9-B-10 / 320C-BSS-MS-MA

P320[®]-M17 / M18



THE CHOSEN ONES

The P320-M17 and P320-M18 are the civilian versions of the M17[®] and M18[®], which are the official sidearms of all branches of the U.S. military. The P320-M17 and M18 deliver the same unprecedented accuracy, extreme reliability, and unmatched durability that the U.S. military demands from each and every one of their firearms.

9mm

SHARED FEATURES

- ▲ Based on the M17 / M18 pistol in use with the U.S. Military
- ▲ Coyote tan stainless steel slide
- ▲ Modular striker-fired pistol
- ▲ Ambi-manual safety
- ▲ Night sight rear plate, optic-ready
- ▲ 1913 rail
- ▲ Front cocking serrations
- ▲ Coyote tan polymer grip
- ▲ Front SIGLITE[®] night sight
- ▲ (2) 21rd / (1) 17rd magazine

M17 / M18



(2) 21RD / (1) 17RD MAGAZINE



INTERCHANGEABLE COYOTE GRIP MODULES



NIGHT SIGHT REAR PLATE, OPTIC READY



P320 - M18

- ▲ Based on the M18[®] pistol in use with the U.S. Military
- ▲ Ambi-manual safety
- ▲ Night sight rear plate, optic-ready



P320 - M17

- ▲ Based on the M17[®] pistol in use with the U.S. Military
- ▲ Ambi-manual safety
- ▲ Night sight rear plate, optic-ready

TESTED AND ABUSED

THROUGH ITS ADOPTION BY THE U.S. MILITARY AND COUNTLESS OTHER MILITARY AND LAW ENFORCEMENT AGENCIES AROUND THE WORLD, THE P320 SURPASSED SOME OF THE MOST RUGGED AND GRUELING TESTING PROTOCOLS IN THE HISTORY OF FIREARMS.

STATE COMPLIANT MODELS AVAILABLE

320F-9-M17-MS-10 / 320F-9-M17-MS-MA / 320CA-9-M18-MS-10

P320	SKU	Caliber	Magazine Capacity	Length (in)	Height (in)	Width (in)	Barrel Length (in)	Sight Radius (in)	Weight w/Mag (oz)	Sights	Grip Type	Slide Material	Slide Finish	Trigger Action
M17	320F-9-M17-MS	9mm	17/21	8.0	5.5	1.6	4.7	6.6	29.5	Night Sight Rear Plate, Optic-Ready SIGLITE Front	Coyote Tan Polymer	Stainless	Coyote Tan	Striker
M18	320CA-9-M18-MS	9mm	17/21	7.2	5.5	1.6	3.9	5.8	26.5	Night Sight Rear Plate, Optic-Ready SIGLITE Front	Coyote Tan Polymer	Stainless	Coyote Tan	Striker

P320[®] XSERIES



MAX MICHEL
Captain
TEAM SIG

THE STANDARD OF PERFORMANCE

XSERIES models include the enhanced XSERIES grip module with extended beavertail, 4-sided beveled magwell, and a deep trigger guard undercut. The flat trigger and optic-ready slide make the P320X stand above the rest.

9mm

SHARED FEATURES

- ▲ 9mm Luger
- ▲ Modular striker-fired pistol
- ▲ XSERIES optic ready slide compatible with ROME01PRO
- ▲ 1913 rail
- ▲ Front cocking serrations
- ▲ XSERIES grip
- ▲ XSERIES flat trigger

XSERIES



LIGHTENED SKELETONIZED TRIGGER



TXG HEAVY XSERIES GRIP MODULE (X5SERIES)



REAR PLATE ASSEMBLY COMPATIBLE WITH ROME01PRO



LEGION[®] XCARRY

- ▲ 4.6" threaded barrel (1/2X28)
- ▲ XRAY3 adjustable day/night sights
- ▲ TXG heavy XCARRY grip module



LEGION XFIVE[®]

- ▲ Lightened skeletonized trigger
- ▲ Dawson[®] removable rear sight assembly compatible with ROME01PRO™
- ▲ TXG™ heavy XSERIES grip module



XFULL

- ▲ X-RAY3™ day/night sights
- ▲ Night sight rear plate, assembly compatible with ROME01 PRO
- ▲ XCARRY grip module



XVTAC[®]

- ▲ VTAC day/night sights
- ▲ FDE stainless slide compatible with ROME01PRO
- ▲ XCARRY grip module



XCOMPACT

- ▲ X-RAY3™ day/night sights
- ▲ Night sight rear plate, assembly compatible with ROME01PRO
- ▲ XCOMPACT Grip Module



STATE COMPLIANT MODELS AVAILABLE

320X5-9-LEGION-R2-10 / 320XCA-9-LEGION-TB-R2-10 / 320XF-9-BXR3-R2-10 / 320XC-9-BXR3-R2-10

P320	SKU	Caliber	Magazine Capacity	Length (in)	Height (in)	Width (in)	Barrel Length (in)	Sight Radius (in)	Weight w/Mag (oz)	Sights	Grip Type	Slide Material	Slide Finish	Trigger Action
XCARRY LEGION	320XCA-9-LEGION-TB-R2	9mm	17	8.1	5.8	1.6	4.6	5.8	40.0	XRAY3 Day / Night Adj Sights	LEGION Gray TXG	Stainless	LEGION Gray	Striker
XFIVE LEGION	320X5-9-LEGION-R2	9mm	17	8.5	5.8	1.6	5.0	6.9	43.5	Dawson Adj Plate / Fiber Optic	LEGION Gray TXG	Stainless	LEGION Gray	Striker
XFULL	320XF-9-BXR3-R2	9mm	17	8.2	5.5	1.3	4.7	6.6	29.5	XRAY3 Day / Night Sights	Black Polymer	Stainless	NITRON	Striker
XVTAC	320XF-9-VTAC-R2	9mm	17	8.2	5.6	1.3	4.7	6.6	29.5	VTAC Day / Night Sights	Black Polymer	Stainless	FDE	Striker
XCOMPACT	320XC-9-BXR3-R2	9mm	15	7.0	5.3	1.3	3.6	5.5	25.3	XRAY3 Day / Night Sights	Black Polymer	Stainless	NITRON	Striker

P320 AXG SERIES

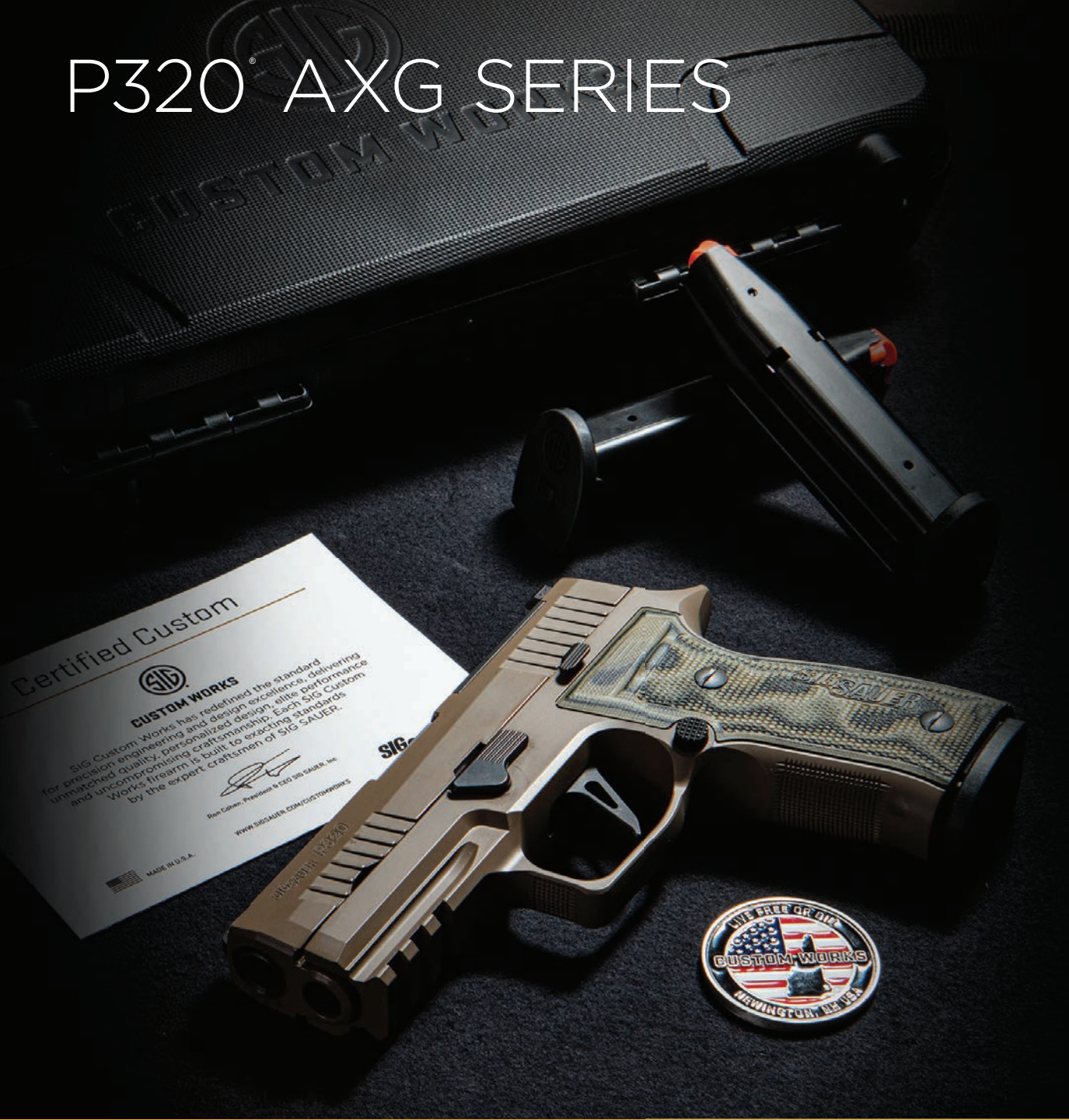

PERFORMANCE YOU CAN FEEL

The CUSTOM WORKS P320 AXG™ Scorpion combines the weight and balance of a metal framed pistol with the performance and reliability of the P320, delivering a uniquely refined shooting experience unlike anything else.

Utilizing the new AXG XSERIES metal grip module as a foundation, the SIG CUSTOM WORKS team has carefully selected a set of premium options and performance upgrades, creating a limited edition P320 that blends the style and shootability of a classic metal frame pistol with the modern features you expect from the P320. And like all Custom Works products, it's delivered in an exclusive, ultra-premium package.

9mm

FEATURES

- ▲ AXG Carry grip module
- ▲ XSERIES optic-ready slide
- ▲ XRAY3 day/night sights
- ▲ 1913 rail
- ▲ Flat XSERIES trigger
- ▲ Redesigned magazine catch
- ▲ Extended slide catch lever



LIGHTENED SKELETONIZED TRIGGER



CUSTOM HOGUE PIRANHA G-10 GRIPS AND INSERT



XRAY3 DAY-NIGHT SIGHTS WITH OPTIC-READY SLIDE



CUSTOM WORKS AXG™ SCORPION

- ▲ Elite Series Cerakote FDE finish
- ▲ Skeletonized trigger with lighter pull
- ▲ Hogue® G10 with Piranha textured grips and back strap
- ▲ Custom Works case, coin, and certificate
- ▲ 3EA 17rd steel magazines

STATE COMPLIANT MODELS AVAILABLE

320AXGCA-9-CW-SCPN-R2-10

AXG	SKU	Caliber	Magazine Capacity	Length (in)	Height (in)	Width (in)	Barrel Length (in)	Sight Radius (in)	Weight w/Mag (oz)	Sights	Grip Type	Slide Material	Slide Finish	Trigger Action
SCORPION	320AXGCA-9-CW-SCPN-R2	9mm	17	7.4	5.5	1.3	3.9	5.8	31.3	XRAY3 day/night sights	FDE Cerakote AXG	Stainless	Cerakote FDE	Striker

P320® RXP SERIES

RED DOT ACCURACY RIGHT OUT-OF-THE-BOX

The new P320 RXP™ SERIES is the next generation of pistol and optics solutions from SIG SAUER®. The RXP SERIES combines the latest advancements in reflex optics, with the world's most innovative handgun. Featuring the new ROMEO1PRO™, each of the RXP SERIES pistols delivers a new level of durability and performance. Available on both the standard and XSERIES P320 pistols, the RXP SERIES are zeroed and ready to shoot, right out-of-the-box allowing users to easily achieve a whole new level of accuracy and performance.

9mm

SHARED FEATURES

- ▲ NITRON® stainless steel slide with ROMEO1PRO reflex sight installed
- ▲ Modular striker-fired pistol
- ▲ Suppressor height back-up sights
- ▲ 1913 rail
- ▲ Front cocking serrations
- ▲ Polymer grip



FLAT TRIGGER (XSERIES)



ROMEO1PRO XRAY3 SUPPRESSOR SIGHTS (XSERIES)



ROMEO1PRO CONTRAST 3-DOT SUPPRESSOR SIGHTS (FULL-SIZE, COMPACT)



XSERIES

XFULL RXP™

- ▲ X-RAY3™ day/night suppressor sights
- ▲ NITRON XSERIES Slide with ROMEO1PRO™ installed
- ▲ XCARRY grip module

XSERIES

XCOMPACT RXP

- ▲ X-RAY3™ day/night suppressor sights
- ▲ NITRON® XSERIES Slide with ROMEO1PRO installed
- ▲ XCOMPACT grip module



FULL-SIZE RXP

- ▲ Contrast suppressor sights
- ▲ Standard NITRON Slide with ROMEO1PRO installed
- ▲ Full-size grip module



COMPACT RXP

- ▲ Contrast suppressor sights
- ▲ Standard NITRON Slide with ROMEO1PRO installed
- ▲ Compact grip module

P320	SKU	Caliber	Magazine Capacity	Length (in)	Height (in)	Width (in)	Barrel Length (in)	Sight Radius (in)	Weight w/Mag (oz)	Sights	Grip Type	Slide Material	Slide Finish	Trigger Action
FULL-SIZE RXP	320F-9-B-RXP	9mm	17	8	6.4	1.4	4.7	6.6	30.0	ROMEO1PRO Contrast 3-Dot Suppressor Sights	Black Polymer	Stainless	NITRON	Striker
COMPACT RXP	320C-9-B-RXP	9mm	15	7.2	6.2	1.4	3.9	5.8	26.3	ROMEO1PRO Contrast 3-Dot Suppressor Sights	Black Polymer	Stainless	NITRON	Striker
XFULL RXP	320XF-9-BXR3-RXP	9mm	17	8.2	6.4	1.4	4.7	6.6	30.0	ROMEO1PRO X-RAY3™ Day/Night Suppressor Sights	Black Polymer	Stainless	NITRON	Striker
XCOMPACT RXP	320XC-9-BXR3-RXP	9mm	15	7.0	6.2	1.4	3.6	5.5	25.3	ROMEO1PRO X-RAY3™ Day/Night Suppressor Sights	Black Polymer	Stainless	NITRON	Striker

STATE COMPLIANT MODELS AVAILABLE

320XF-9-BXR3-RXP-10 / 320XC-9-BXR3-RXP-10 / 320F-9-B-RXP-10 / 320C-9-RXP-10



FULL-SIZE POLYMER HAMMER-FIRED

The SP2022 is a full-size polymer pistol inspired by the SIG classic line. The SP2022 features the same DA/SA trigger found in SIG SAUER[®] Classic Line pistols, with a durable, lightweight and wear-resistant polymer frame with an integrated M1913 accessory rail. The SP2022 pistols have earned an enviable reputation and proven track record of reliable performance in the hands of military and law enforcement professionals around the world.

9mm

FEATURES

- ▲ NITRON[®] stainless steel slide
- ▲ SIGLITE[®] night sights
- ▲ Small and medium grip sizes available
- ▲ 1913 rail
- ▲ Polymer grip

ALL THE CLASSIC LINE SIG FEATURES
IN A LIGHTWEIGHT AND DURABLE POLYMER PACKAGE.



SP2022 FIRE CONTROL



SMALL AND MEDIUM GRIP SIZES AVAILABLE



SMOOTH DA/SA TRIGGER



NITRON[®]

- ▲ NITRON[®] stainless steel slide
- ▲ SIGLITE[®] night sights
- ▲ Small and medium grip sizes available

STATE COMPLIANT MODELS AVAILABLE

SP2022-9-BSS-CA

SP2022	SKU	Caliber	Magazine Capacity	Length (in)	Height (in)	Width (in)	Barrel Length (in)	Sight Radius (in)	Weight w/Mag (oz)	Sights	Grip Type	Slide Material	Slide Finish	Trigger Action
NITRON	E2022-9-BSS	9mm	15 / 12	7.4	5.7	1.4	3.9	5.9	29.0	SIGLITE Night Sights	Polymer	Stainless	NITRON	DA/SA



CLASSIC FULL-SIZE PISTOL

The SIG SAUER P226 set the standard by which all other combat handguns are measured. The iconic P226 served alongside the U.S. Navy SEALs for decades and has seen action around the globe. With legacy of accuracy and reliability, and millions upon millions of rounds of proven performance, it has earned its reputation as the premiere combat pistol.

9mm

SHARED FEATURES

- ▲ All metal pistol
- ▲ Accessory rail
- ▲ Four-point safety system
- ▲ 15rd steel magazines
- ▲ Polymer or G10 grip panels



G-10 GRIPS WITH MEDALLION (LEGION® SERIES)



ROMEOPRO RED DOT SIGHT INSTALLED (LEGION RXP)



ANCHOR ENGRAVING, UID LABEL (MK25)



LEGION® RXP

- ▲ LEGION gray finished slide and frame
- ▲ Custom Works inspired flat trigger (SAO)
- ▲ X-RAY3™ day/night sights with ROMEOPRO™ reflex sight



LEGION

- ▲ LEGION gray finished slide and frame
- ▲ Grayguns Inc. designed trigger (DA/SA)
- ▲ X-RAY3™ day/night sights



MK25

- ▲ 1913 Accessory Rail
- ▲ Corrosion-resistant internal coating
- ▲ Anchor engraving, UID label



ELITE

- ▲ Beavertail frame
- ▲ Front cocking serrations
- ▲ Short reset trigger -SRT



STATE COMPLIANT MODELS AVAILABLE

226RM-9-LEGION / 226RM-9-LEGION-SAO / 226R-9-BSS-CA / 226R-9-SCPN-CA / MK-25-CA / MK-25-MA / 226R-9-XTM-BLKGRY-CA

P226	SKU	Caliber	Magazine Capacity	Length (in)	Height (in)	Width (in)	Barrel Length (in)	Sight Radius (in)	Weight w/Mag (oz)	Sights	Grip Type	Slide Material	Slide Finish	Trigger Action
LEGION RXP SAO / DA/SA	E26R-9-LEGION-SAO-RXP/ E26R-9-LEGION-RXP	9mm	15	7.7	5.5	1.7 / 1.5	4.4	6.3	35.4	ROMEOPRO/ X-RAY3	Black G-10	Stainless	LEGION Gray	SAO/ DA/SA
LEGION SAO / DA/SA	E26R-9-LEGION/ E26R-9-LEGION-SAO	9mm	15	7.7	5.5	1.7 / 1.5	4.4	6.3	34.4	X-RAY3	Black G-10	Stainless	LEGION Gray	SAO/ DA/SA
MK25	MK-25	9mm	15	7.7	5.5	1.5	4.4	6.3	34.0	SIGLITE Night Sights	Black Polymer	Stainless	NITRON	DA/SA
ELITE	E26R-9-BSE	9mm	15	7.7	5.5	1.5	4.4	6.3	34.0	SIGLITE Night Sights	Black Polymer	Stainless	NITRON	DA/SA



CLASSIC COMPACT PISTOL

The SIG SAUER P229 incorporates all the features of the P226 in a smaller, more compact package. Originally designed to meet the needs of law enforcement, today's P229 has been engineered to meet the most demanding reliability standards while delivering the highest possible performance.

9mm

SHARED FEATURES

- ▲ All metal pistol
- ▲ Four-point safety system
- ▲ 15rd steel magazines
- ▲ Polymer or G10 grip panels



LEGION®

- ▲ LEGION gray finished slide and frame
- ▲ Custom Works inspired flat trigger (SAO)
- ▲ X-RAY3™ day/night sights



LEGION RXP

- ▲ LEGION gray finished slide and frame
- ▲ Grayguns Inc. designed trigger (DA/SA)
- ▲ X-RAY3™ day/night sights with ROMEO1PRO™ reflex sight



M11-A1

- ▲ Non railed alloy frame
- ▲ 15rd magazines
- ▲ UID label



ELITE

- ▲ Beavertail frame
- ▲ Front cocking serrations
- ▲ Short reset trigger -SRT



G-10 GRIPS WITH MEDALLION (LEGION® SERIES)



ROMEO1PRO RED DOT SIGHT INSTALLED (LEGION RXP)



UID LABEL (M11-A1)

STATE COMPLIANT MODELS AVAILABLE

229R-9-BSS-CA / 229R-9-ESE-CA / 229RM-9-LEGION / 229RM-9-LEGION-SAO

P229	SKU	Caliber	Magazine Capacity	Length (in)	Height (in)	Width (in)	Barrel Length (in)	Sight Radius (in)	Weight w/Mag (oz)	Sights	Grip Type	Slide Material	Slide Finish	Trigger Action
LEGION RXP SAO / DA/SA	229R-9-LEGION-SAO-RXP/ E29R-9-LEGION-RXP	9mm	15	7.1	5.4	1.7 / 1.5	3.9	5.7	32.0	ROMEO1PRO/ X-RAY3 Day / Night Sights	Black G-10	Stainless	LEGION Gray	SAO/ DA/SA
LEGION SAO / DA/SA	229R-9-LEGION-SAO/ E29R-9-LEGION	9mm	15	7.1	5.4	1.7 / 1.5	3.9	5.7	32.0	X-RAY3 Day / Night Sights	Black G-10	Stainless	LEGION Gray	SAO/ DA/SA
M11-A1	M11-A1	9mm	15	7.1	5.4	1.5	3.9	5.7	32.0	SIGLITE Night Sights	Black Polymer	Stainless	NITRON	DA/SA
ELITE	E29R-9-BSE	9mm	15	7.1	5.4	1.5	3.9	5.7	32.0	SIGLITE Night Sights	Black Polymer	Stainless	NITRON	DA/SA



CLASSIC FULL-SIZE PISTOL

With origins dating back to the late 1970s, the P220 is considered by many to be the one that started it all for SIG SAUER. This classic has been reborn, with the same quality, accuracy and reliability that the Swiss Army has relied on for decades. The P220 was built to meet and exceed rigorous military standards. Available in both carry and full-size, the legendary P220 lives on, allowing you to put all-metal power in your corner.

45AUTO **10MM**

SHARED FEATURES

- ▲ All metal pistol
- ▲ 8rd magazine
- ▲ Accessory rail



LEGION® SAO

- ▲ LEGION gray finished slide and frame
- ▲ Custom Works inspired flat trigger (SAO)
- ▲ X-RAY3™ day/night sights



LEGION

- ▲ LEGION gray finished slide and frame
- ▲ Grayguns Inc. designed trigger (DA/SA)
- ▲ X-RAY3™ day/night sights



LEGION 10MM

- ▲ LEGION gray finished slide and frame
- ▲ Five inch match grade barrel
- ▲ Stainless steel frame and slide



ELITE

- ▲ Beavertail frame
- ▲ Front cocking serrations
- ▲ Short reset trigger SRT



G-10 GRIPS WITH MEDALLION (LEGION® SERIES)

LEGION GREY STAINLESS STEEL FRAME /SLIDE

X-RAY3™ DAY/NIGHT SIGHTS

STATE COMPLIANT MODELS AVAILABLE

220RM-45-LEGION / 220R-45-BSS-CA

P220	SKU	Caliber	Magazine Capacity	Length (in)	Height (in)	Width (in)	Barrel Length (in)	Sight Radius (in)	Weight w/Mag (oz)	Sights	Grip Type	Slide Material	Slide Finish	Trigger Action
LEGION SAO	220R-45-LEGION-SAO	45AUTO	8	7.7	5.5	1.3	4.4	6.3	30.4	X-RAY3 Day / Night Sights	Black G-10	Stainless	LEGION Gray	SAO
LEGION	220R-45-LEGION	45AUTO	8	7.7	5.5	1.3	4.4	6.3	30.4	X-RAY3 Day / Night Sights	Black G-10	Stainless	LEGION Gray	DA/SA
LEGION 10MM	220R5-10-LEGION-SAO / 220R5-10-LEGION	10mm	8	8.3	5.5	1.5 / 1.3	5.0	6.9	44.0	X-RAY3 Day / Night Sights	Black G-10	Stainless	LEGION Gray	SAO / DA/SA
ELITE	220R-45-BSE	45AUTO	8	7.7	5.5	1.3	4.4	5.7	30.4	SIGLITE Night Sights	Black Polymer	Stainless	NITRON	DA/SA



CLASSIC 45 AUTO PISTOL

The classic 1911, with its legendary ergonomics and accuracy has been engineered with modern refinements and SIG reliability. We have given history's most revered pistol 21st Century updates, providing the features that meet the demands of modern shooters. Thanks to their all-metal frames, rugged construction and protective coatings, SIG SAUER 1911's are built to age just as well as Browning's original design.

45AUTO **10MM**

SHARED FEATURES

- ▲ .45 AUTO/10mm
- ▲ Stainless steel slide and frame
- ▲ SAO trigger
- ▲ 8rd magazines
- ▲ Extended beavertail safety

THE CLASSIC 1911 HAS JOINED THE RED DOT REVOLUTION



EXTENDED BEAVERTAIL SAFETY



FRONT COCKING SERRATIONS (EMPEROR SCORPION)



ROMEOZERO REFLEX SIGHT (TACOPS RXZ)



TACOPS RXZ

- ▲ NITRON® stainless steel slide with ROMEOZero™ installed
- ▲ SIGLITE® Night sights
- ▲ Polymer grips with SIG medallion
- ▲ 8rd magazines

EMPEROR SCORPION

- ▲ Stainless steel fde slide and frame
- ▲ Custom black G-10 grips with magwell
- ▲ Fastback rounded frame (Fastback Version)

TACOPS

- ▲ NITRON® coated frame and slide
- ▲ 8rd magazines
- ▲ Metal magwell

STX

- ▲ Custom two tone slide
- ▲ Burl maple grips
- ▲ Metal magwell

CARRY NIGHTMARE

- ▲ Carry length 4.2" Barrel
- ▲ Fastback rounded frame
- ▲ NITRON frame with nickel controls

STATE COMPLIANT MODELS AVAILABLE

1911R-45-BSS-CA / 1911R-45-SSS-CA / 1911M-45-STX / 1911RM-45-ESCPN

1911	SKU	Caliber	Magazine Capacity	Length (in)	Height (in)	Width (in)	Barrel Length (in)	Sight Radius (in)	Weight w/Mag (oz)	Sights	Grip Type	Slide Material	Slide Finish	Trigger Action
TACOPS RXZ	1911R-45-TACOPS-RXZ 1911CAR-45-TACOPS-RXZ	45AUTO	8	8.7 / 7.7	TBD	1.4	5.0 / 4.2	6.5 / 5.7	41.6 / 38.8	SIGLITE Night Sights	Black Polymer	Stainless	NITRON	SAO
EMPEROR SCORPION	1911R-45-ESCPN / 1911FTCA-45-ESCPN	45AUTO	8	8.7 / 7.7	5.5	1.4	5.0 / 4.2	6.5 / 5.7	41.6 / 38.8	SIGLITE Night Sights	Black G-10	Stainless	FDE PVD	SAO
TACOPS	1911R-10-TACOPS	10mm	8	8.7	5.5	1.4	5.0	6.5	41.6	SIGLITE Night Sights	Black Polymer	Stainless	NITRON	SAO
STX	1911M-45-STX	45AUTO	8	8.7	5.5	1.4	5.0	6.5	41.6	SIGLITE Night Sights	Burl Maple	Stainless	NITRON	SAO
FASTBACK CARRY NIGHTMARE	1911FTCA-45-ESCPN	45AUTO	8	7.7	5.5	1.4	4.2	5.7	38.8	SIGLITE Night Sights	Black G-10	Stainless	NITRON	SAO

P238® / P938®



MICRO-COMPACT PISTOLS

The 1911 inspired the micro-compact all metal P238 and P938, providing exceptional accuracy in an easy-to-conceal package. The P238, built to perform and please every shooter inspired the P938, which delivers the same accuracy and reliability with duty caliber performance. Together, the P238 and P938 form a family of classic firearms ready to stand the test of time.

9mm 380 AUTO

SHARED FEATURES

- ▲ 9mm or 380 ACP
- ▲ All metal pistol
- ▲ 3" barrel (938) 2.7" (238)
- ▲ SAO trigger



LEGION® P938®

- ▲ LEGION gray finished slide and frame
- ▲ Flat trigger
- ▲ Black G10 grips



P938 SAS®

- ▲ SIG anti snag treatment -SAS
- ▲ FT-Bullseye day/night sight
- ▲ 7 round magazine



P938 BRG

- ▲ SIGLITE® night sights
- ▲ Ambidextrous mag safety
- ▲ 7 round magazine



P238® NITRON®

- ▲ NITRON coated stainless steel slide
- ▲ Steel contrast sights
- ▲ Black polymer grip



LEGION® GRAY SLIDE AND FRAME



CUSTOM FLUSH-FIT TRITIUM SIGHT (SAS)



BLACK RUBBER GRIP, EXTENDED 7RD MAG (BRG)

STATE COMPLIANT MODELS AVAILABLE

938M-9-BRG-AMBI / 938M-9-LEGION / 238-380-TSS2-CA

238/938	SKU	Caliber	Magazine Capacity	Length (in)	Height (in)	Width (in)	Barrel Length (in)	Sight Radius (in)	Weight w/Mag (oz)	Sights	Grip Type	Slide Material	Slide Finish	Trigger Action
938 LEGION	938-9-LEGION	9mm	7	5.9	3.9	1.1	3.0	4.0	16.0	X-RAY3 Day / Night Sights	Black G-10	Stainless	LEGION Gray	SAO
938 SAS	938-9-SAS2B	9mm	7	5.9	3.9	1.1	3.0	4.0	16.0	FT Bullseye	Black Rubber	Stainless	NITRON	SAO
938 BRG	938-9-BRG-AMBI	9mm	7	5.9	3.9	1.1	3.0	4.0	16.0	SIGLITE Night Sights	Black Rubber	Stainless	NITRON	SAO
238 NITRON	238-380-B	380ACP	6	5.5	3.9	1.1	2.7	3.8	15.2	Contrast	Black Polymer	Stainless	NITRON	SAO

P210



HERITAGE. TRADITION. PERFORMANCE.

Now you can own one of the finest firearms ever made with the new P210 Target from SIG SAUER® - the latest in the historic line of pistols from SIG. Crafted with unprecedented precision, the P210 Target combines the classic lines and heritage of the original, with updated ergonomics, and a target trigger delivering unparalleled accuracy and shooting performance. And new this year, the P210 Carry, the same precision and ergonomics in a smaller, lighter package.

9mm

SHARED FEATURES

- ▲ All metal pistol
- ▲ Reverse-railed slide and frame
- ▲ Updated ergonomic controls



ERGONOMIC SAFETY AND SLIDE CATCH LEVER



CHECKERED G-10 GRIPS (CARRY)



ADJUSTABLE TARGET SIGHTS (TARGET)



new
CARRY

- ▲ Light weight Alloy frame
- ▲ Black G-10 Grips
- ▲ SIGLITE® Night sights
- ▲ 4.1 inch Barrel



TARGET

- ▲ Adjustable target sights
- ▲ Checkered walnut target grip with magwell
- ▲ 5 inch Barrel

ONE OF THE FINEST HANDGUNS EVER MADE.

With a history that dates back to 1949, the SIG SAUER P210 was the combat handgun for the Swiss Military and is regarded as one of the most legendary, reliable, and accurate firearms in the world. SIG SAUER, Inc. has introduced the American Made P210 Standard pistol to the U.S. Commercial Market, featuring modern improvements, at a price-point allowing more consumers to enjoy this timeless pistol.

P210	SKU	Caliber	Magazine Capacity	Length (in)	Height (in)	Width (in)	Barrel Length (in)	Sight Radius (in)	Weight w/Mag (oz)	Sights	Grip Type	Slide Material	Slide Finish	Trigger Action
TARGET	210A-9-TGT	9mm	8	8.4	5.3	1.5	5.0	6.7	36.9	Adjustable Target	Walnut Target	Stainless	NITRON	SAO
CARRY	210CA-9-BSS	9mm	8	7.5	5.3	1.5	4.1	5.6	32.0	SIGLITE Night Sights	Custom G-10	Stainless	NITRON	SAO

LEGION® SERIES



UNLEASH THE WARRIOR SPIRIT

For thousands of years, one symbol has been a rallying cry for the world's most revered warriors. And for decades, one brand of firearms has served more elite fighting forces than any other.

Welcome to the LEGION® by SIG SAUER®. Painstakingly engineered and enhanced for the discerning few with the same warrior spirit that inspired it. We have always given professionals what they need. Now, we are giving them what they want.

The SIG P220®, P226®, P229®, P320®, P938®; five of the most highly regarded firearms in the professional community are receiving the LEGION Series enhancements based on the needs and wants of elite users. For those who demand the best, we now have something even better — welcome to the LEGION.

JOIN THE LEGION.

Become part of the SIG SAUER® LEGION for members-only access to unique opportunities and gear. To join the LEGION, purchase and register your LEGION Series™ firearm, and unlock a full range of exclusive benefits.

FREE Gear LEGION membership entitles you to a complimentary 5.11® premium zippered pistol case for your LEGION firearm, plus a challenge coin matched to your gun.

Exclusive Access When you call to receive your free case and coin, you will be automatically registered as a LEGION member, providing you exclusive access to gear and merchandise.

Exclusive Communications Be the first to know about new additions to the LEGION Series of firearms. You'll also receive other exclusive communications from SIG SAUER and the LEGION.

LEGION SERIES



LEGION® ENHANCEMENTS

- 1 **LEGION Gray Finish**
Enhances durability & lubricity
- 2 **Solid Steel Guide Rod**
Reduces muzzle flip
- 3 **Checkering Under Trigger Guard**
Minimizes lateral movement
- 4 **XFIVE Undercut**
Accommodates high grip techniques
- 5 **Grayguns Inc. Designed Trigger**
Adjustable for over-travel
- 6 **Reduced Profile Controls**
Prevents premature activation of slide stop with improved texture for better control
- 7 **Three Magazines**
Delivers more value
- 8 **Elite Beavertail Reduction**
Reduces printing when concealed
- 9 **Enhanced Polished Action with SRT**
Smoother DA trigger press that enables faster follow-up shots
- 10 **Front Cocking Serrations**
For easy slide operation
- 11 **Custom G10 Grips**
Provides enhanced control for high grip techniques
- 12 **Tungsten Grip Module**
Tungsten Infused Module, with the weight of steel and the flex of polymer
- 13 **X-RAY3™ Sights**
Optimizes sight acquisition in all lighting conditions
- 14 **Dawson Precision®**
fiber optic adjustable sight
- 15 **Enhanced Front Strap Checkering**
Provides a more secure grip for better control
- 16 **Extended Magwell**
Provides a larger flared opening for faster reloading
- 17 **ROME01 Reflex Sight**
Legion RX is equipped with a slide-mounted reflex optic

LEGION® SERIES



220 LEGION



220 LEGION SAO



220 LEGION 10MM



220 LEGION 10MM SAO



226 LEGION



226 LEGION RXP



226 LEGION SAO



226 LEGION SAO RXP



229 LEGION



229 LEGION RXP



229 LEGION SAO



229 LEGION SAO RXP



320 XCARRY LEGION



320 XFIVE LEGION



938 LEGION



LEGION® GEAR

LEGION members get exclusive access to LEGION gear and merchandise unavailable anywhere else.

X300 WEAPON LIGHT

- ▲ The standard for professional use weapon lights
- ▲ Total Internal Reflection (TIR) lens to produce a tight beam with extended reach and significant surround light for peripheral vision
- ▲ The virtually indestructible and highly efficient LED generates tactical-level light
- ▲ Ambidextrous switching located at the rear of body
- ▲ 1,000 Lumens



BLACKPOINT® TACTICAL POLYWING OWB HOLSTER

- ▲ Durable construction
- ▲ Premium fit and finish designed in collaboration with BlackPoint and SIG SAUER
- ▲ Flexible poly wing for the comfort of soft holsters and the security of thermal molded holsters
- ▲ Adjustable retention



MITCH ROSEN EXTRAORDINARY GUNLEATHER™ HOLSTER

- ▲ Comfortable for every day, all day use
- ▲ Premium fit and finish designed in collaboration with Mitch Rosen and SIG SAUER
- ▲ Designed for OWB concealment



LEGION FLEECE JACKET

- ▲ Custom designed for LEGION members, subtly branded
- ▲ Water and wind resistant
- ▲ Open bottom hems
- ▲ Relaxed fit



RANDOLPH® AVIATORS

- ▲ Handcrafted custom for SIG SAUER LEGION members
- ▲ Polarized 100% UVA/UVB protection
- ▲ Anti-reflective coating
- ▲ Randolph USA's signature neutral gray tint lenses
- ▲ Frames are guaranteed for life



HOGUE® LEGION X1-MICROFLIP KNIFE

- ▲ SIG SAUER firearm match: LEGION
- ▲ LEGION medallion
- ▲ Locking mechanism: push button lock with manual safety-frame: solid black G10 with checkered texture
- ▲ Pocket clip: stainless steel ambidextrous
- ▲ Right or left handed, tip up deep carry with filler plate
- ▲ Impact pommel



SIG SAUER LEGION RANGE BAG

- ▲ EVA top lid w/internal organization and external loop area for name tags
- ▲ Target straps or compression straps
- ▲ Internal elastic on sides to hold Legion Single Pistol Case.- Padded duffel w/top lid opening
- ▲ External web MOLLE & rear slip pocket-Removable shoulder strap and top / side carry handles
- ▲ 1680D Polyester (lid) & 500D Nylon (main body)
- ▲ Includes separate premium range pouch (padded zippered ammo pouch)

CUSTOM WORKS



LIMITED EDITION PISTOLS

From the very beginning, SIG SAUER® has defined quality and reliability in firearms. Today, SIG Custom Works is creating unique firearms that redefine the standard for precision engineering and design excellence. From special limited-edition pistols, to custom engraving, the mission of SIG SAUER Custom Works is to deliver a personalized design, elite performance and uncompromising craftsmanship. All SIG SAUER Custom Works firearms come packaged in an exclusive Custom Works Negrini® case complete with a SIG Custom Works challenge coin and a certified custom certificate.

**EXCLUSIVE
LIMITED EDITIONS**



P229® CUSTOM WORKS NIGHTMARE

▲ Also available in P220 and P226



P226® CUSTOM WORKS EQUINOX

▲ Also available in P220 and P229



P320® CUSTOM WORKS AXG™ SCORPION



CUSTOM WORKS CASE WITH COMBINATION LOCKS



EXCLUSIVE CUSTOM WORKS CHALLENGE COIN



CERTIFIED CUSTOM WORKS CERTIFICATE

CUSTOM WORKS



CELEBRATING ONE MILLION

The SIG SAUER® P320® and P365® have become two of the most popular and most influential guns in America, and to recognize their historic production milestones, SIG SAUER Custom Works developed a unique, one-of-a-kind commemorative to celebrate the passing of the historic 1 million mark.

In 2020, just over 18 months after its launch the one millionth P365 rolled off the assembly line. To commemorate this rapid ascension into the SIG SAUER history books, SIG SAUER Custom Works crafted the special edition one millionth P365.

P365 FEATURES

- ▲ High polished Nitron slide with 24K gold trigger and controls
- ▲ Engraving: One Millionth P365 and borders with 24K gold inlay
- ▲ The 1,000,000th P365 is a 9mm pistol with standard P365 features including X-RAY3 day/night sights

In 2019, the SIG SAUER P320 reached this historic milestone when serial number 58H1000000 was born. To celebrate SIG SAUER Custom Works created a special edition P320

P320 FEATURES

- ▲ An all-metal frame with a high-gloss polished finished
- ▲ Engraving: Scroll engraving with 14k gold inlay, and "1,000,000th P320"
- ▲ The 1,000,000th P320 is a 9mm pistol with standard P320 features including XRAY-3 day/night sights and an optic cut slide



The SIG SAUER P320

Tested to ensure extreme reliability and durability.

Proven to deliver unprecedented accuracy.

Chosen by the all branches of the US military and the world's most demanding users.

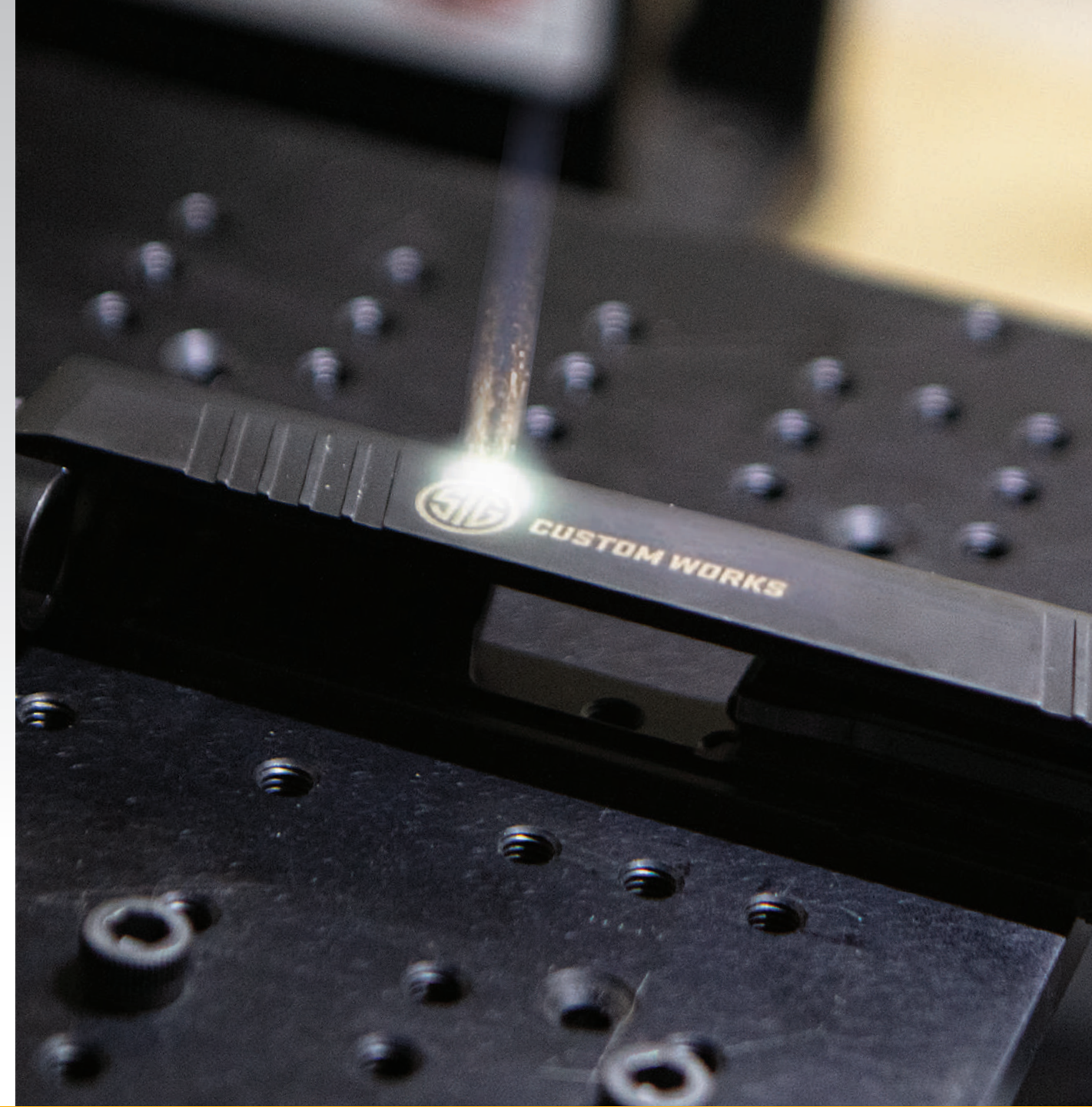

SIG CUSTOM WORKS ENGRAVING PROGRAM

From the very beginning, SIG SAUER® has defined the quality and reliability in firearms. Today, SIG Custom Works is creating unique firearms that redefine the standard for precision engineering and design excellence.

The SIG SAUER Custom Engraving Program provides personalized firearms to commemorate events such as deployments and retirements, as gifts, and fundraising for organizations. The mission of SIG Custom Works is to deliver a personalized design, elite performance, and uncompromising craftsmanship.

ENGRAVING CAPABILITIES

- ▲ Contrast engraving
- ▲ Premium-cut engraving
- ▲ Scroll work
- ▲ Gold inlay
- ▲ Personalized text



CUSTOM WORKS FCU



P320® CUSTOM WORKS FIRE CONTROL UNIT

INTRODUCING THE P320® FIRE CONTROL UNIT.

With its unprecedented modularity and unmatched capability, the P320 platform has become one of the most exciting pistols available to firearms enthusiasts today. The soul of the P320 and the driving force behind its modularity lies in the unique, patented design of its Fire Control Unit (FCU).

Now, SIG SAUER is offering the FCU as a standalone product, enabling an entirely new level of customization and personalization, giving users the ability to create virtually millions of combinations to suit any need and any level of personal style.

TITANIUM NITRIDE COATED: Exclusive to the Custom Works P320 FCU, the added protection of titanium nitride ensures a unique look, with superior corrosion resistance.

EXCLUSIVE FCU SERIAL NUMBER: Stand out from the rest with an "FCU" designated serial number for each Custom Works P320 Fire Control Unit.

LIGHTENED SKELETONIZED TRIGGER: Each Custom Works P320 FCU comes standard with a TiN-coated XSeries skeletonized trigger for a lighter, cleaner trigger pull.



CREATE YOUR CUSTOM P320® TODAY

- 01 Purchase a P320 Custom Works FCU from your local SIG SAUER retailer
- 02 Register your P320 Custom Works FCU at sigsauer.com and Receive your 10% off one time discount code
- 03 Create your P320 using the Custom Works P320 Studio at sigsauer.com
- 04 Save 10% on all qualifying P320 Accessories at check-out using your discount code

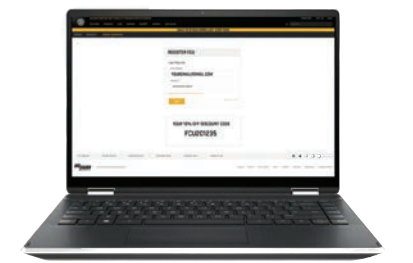

Visit sigsauer.com to see these and the many other P320 accessories available from our preferred partners.

WWW.SIGSAUER.COM/P320FCU

CUSTOM WORKS FCU



COUNTLESS OPTIONS, ENDLESS POSSIBILITIES.

The SIG SAUER® P320® collective brings together a community of manufacturers and customizers focused on pushing the boundaries of creativity and innovation with the P320 platform. With the launch of the Custom Works P320 FCU, SIG SAUER has enabled and encouraged a broad community of creators to develop an ever-increasing number of parts, accessories, and uniquely customized P320 based firearms. Together, the P320: Collective represents the best the industry has to offer in aftermarket P320 performance parts and customized accessories. A vast selection of slides, barrels, grip modules, magazines, and accessories are available to ensure every finished Custom Works P320 FCU product is unique. As the list of available aftermarket products grow, the build options and possibilities increase exponentially.

The Custom Works FCU program is unprecedented in the firearms industry. The days of cookie-cutter pistol ownership are over. No longer will gun buyers be limited by the vision of a single company or designer. Now, they will be able to explore the endless possibilities of the Custom Works P320 FCU and be limited only by their imagination.



CUSTOM WORKS



FCU BUILD POSSIBILITIES

- 1 | **XFULL GRIP, ROMEO1™ PRO**
NITRON® XSERIES full-size slide, full-size barrel, magwell, 21 round magazine
- 2 | **XCARRY COYOTE GRIP**
NITRON compact PROCUT slide, compact barrel, magwell, 21 round coyote magazine
- 3 | **XCARRY GRIP, FDE ROMEO1 PRO**
Coyote compact PROCUT slide, threaded compact barrel, magwell, 21 round magazine
- 4 | **XCARRY STIPPLED GRIP**
Stainless compact PROCUT slide, compact barrel, FOXTROTI™ light, 17 round magazine
- 5 | **XCOMPACT GRIP**
NITRON Subcompact PROCUT slide, subcompact barrel, 15 round magazine



WHAT YOU BUILD IS UP TO YOU!

Visit sigsauer.com to see these and the many other P320 accessories available from our preferred partners.

RIFLES



MCX VIRTUS



THE CHOICE OF THE WORLD'S ELITE

In use by more special operations forces around the world than any other AR, the SIG MCX VIRTUS is engineered for adaptability, sound suppression, and extreme longevity. Featuring user-changeable, cold hammer-forged barrels available in both 5.56 NATO and 300 BLK, with the SIG internal recoil system offering reduced recoil, and a folding stock that makes it the ultimate compact rifle platform.

5.56NATO 300BLK

SHARED FEATURES

- ▲ SIG MATCHLITE™ Duo trigger
- ▲ Interchangeable cold hammer-forged barrel
- ▲ M-LOK® free-float handguard with expanded valve windows
- ▲ Ambidextrous selector, mag release, and charging handle
- ▲ Adjustable gas valve
- ▲ Stealth gray upper/lower receivers and handguard
- ▲ Three prong flash hider

MCX VIRTUS



SIG MATCHLITE DUO TRIGGER



FOLDING AND COLLAPSING 6-POSITION STOCK



PISTOL 11.5 / 9"

- ▲ Available in 5.56 NATO and 300 BLK
- ▲ SIG MATCHLITE Duo trigger
- ▲ Folding, fixed PCB brace



PATROL 16"

- ▲ Available in 5.56 NATO
- ▲ 6-position tele-folding stock
- ▲ Interchangeable cold hammer-forged barrel

STATE COMPLIANT MODELS AVAILABLE

PMCX-11B-TAP-CO

MCX	SKU	Caliber	Action Type	Operating System	Stock Type	Forend Type	Weight w/Mag (lb)	Overall Length (in)	Folded Length (in)	Barrel Length (in)	Rifling	Trigger Type	Mag Type	Mag Capacity
PATROL 16"	RMX-16B-TAP-P	5.56 NATO	Semi-Auto	Gas Piston Rotating Bolt	Tele/Fold 6-Position	Free-Float M-LOK	7.9	36.5	26.5	16.0	1:7	2-Stage Match	AR-15	30
PISTOL 11.5"	PMCX-11B-TAP	5.56 NATO	Semi-Auto	Gas Piston Rotating Bolt	Fixed Folding PCB	Free-Float M-LOK	7.4	31.0	22.0	11.5	1:7	2-Stage Match	AR-15	30
PISTOL 9"	PMCX-300B-9B-TAP	300 BLK	Semi-Auto	Gas Piston Rotating Bolt	Fixed Folding PCB	Free-Float M-LOK	7.0	28.5	19.5	9.0	1:5	2-Stage Match	AR-15	30

MCX VIRTUS



MCX VIRTUS® - NEXT LEVEL MODULARITY AND PERFORMANCE



MCX RATTLER™



THE WORLD'S MOST COMPACT RIFLE

Developed for elite special forces, the SIG MCX Rattler is the most compact rifle in the world. Capable of firing with stock folded from an overall length of 16", it redefines the standard for concealable firepower.

5.56NATO 300BLK

SHARED FEATURES

- ▲ Available in 5.56 NATO and 300 BLK
- ▲ SIG MATCHLITE™ Duo trigger
- ▲ M-LOK® handguard
- ▲ Ambidextrous selector, mag release, and charging handle
- ▲ Adjustable gas valve



SUPPRESSOR-READY SD-MLOK HANDGUARD AND INERT TRAINER (CANEBRAKE)



SIG MATCHLITE DUO TRIGGER



CANEBRAKE™ 5.5"

- ▲ Available in 300 BLK
- ▲ Cerakote® E190 upper and lower receiver
- ▲ Suppressor-ready SD-MLOK handguard and inert trainer
- ▲ PCB folding brace



SBR 5.5"

- ▲ Available in 5.56 NATO and 300 BLK
- ▲ Fixed Folding Mini Stock
- ▲ Three prong flash hider



PCB™ 5.5"

- ▲ Available in 5.56 NATO and 300 BLK
- ▲ Folding, fixed PCB brace
- ▲ Three prong flash hider

RATTLER	SKU	Caliber	Action Type	Operating System	Stock Type	Forend Type	Weight w/ Mag (lb)	Overall Length (in)	Folded Length (in)	Barrel Length (in)	Rifling	Trigger Type	Mag Type	Mag Capacity
Canebrake 5.5"	PMCX-300B-SB-TAP-CANE	300 BLK	Semi-Auto	Gas Piston Rotating Bolt	Fixed Folding PCB	Free-Float M-LOK	6.8	29.3	21.0	5.5	1:5	2-Stage Match	AR-15	30
SBR 5.5"	RMCX-SB-TAP-SBR / RMCX-300B-SB-TAP-SBR	5.56 NATO / 300 BLK	Semi-Auto	Gas Piston Rotating Bolt	Fixed Folding Mini Stock	Free-Float M-LOK	5.7	23.5	16.0	5.5	1/7 / 1/5	2-Stage Match	AR-15	30
PCB 5.5"	PMCX-SB-TAP / PMCX-300B-SB-TAP	5.56 NATO / 300 BLK	Semi-Auto	Gas Piston Rotating Bolt	Fixed Folding PCB	Free-Float M-LOK	5.7	23.5	16.0	5.5	1/7 / 1/5	2-Stage Match	AR-15	30



LENA MICULEK
Pro Shooter
TEAM SIG

GAS PISTON SUB-GUN

The MPX sets a new standard for performance and quality in the sub-gun category. Featuring AR style controls and a closed-bolt piston system, the MPX is designed to fulfill the needs of competitive, professional, and civilian users.

9mm

SHARED FEATURES

- ▲ AR style controls
- ▲ Closed-bolt piston system
- ▲ Timney MPX trigger (K, PCC)
- ▲ Integrated pistol brace knuckle (Copperhead, Copperhead K)
- ▲ Monolithic upper receiver (Copperhead, Copperhead K)



FREE-FLOATING ERGONOMIC SLIM LINE M-LOK HANDGUARD (PCC)



MONOLITHIC UPPER RECEIVER (COPPERHEAD, COPPERHEAD K)



K

- ▲ Timney single-stage trigger
- ▲ Free-floating M-LOK handguard
- ▲ Folding fixed PCB brace



COPPERHEAD™

- ▲ Monolithic upper
- ▲ 3.5" barrel with integrated brake
- ▲ Rapid deploy PCB brace



PCC 16"

- ▲ Timney single-stage trigger
- ▲ 16" threaded barrel
- ▲ Narrow M-LOK® free-floating handguard
- ▲ 5-Position tele-folding stock



COPPERHEAD K

- ▲ Timney single-stage trigger
- ▲ 4.5" threaded barrel
- ▲ Rapid deploy PCB brace

STATE COMPLIANT MODELS AVAILABLE

PMPX-3B-CH-CO

MPX	SKU	Caliber	Action Type	Operating System	Stock Type	Forend Type	Weight w/mag (lb)	Overall Length (in)	Folded Length (in)	Barrel Length (in)	Rifling	Trigger Type	Mag Type	Mag Capacity
PCC 16"	RMPX-16B-9	9mm	Semi-Auto	Gas Piston Rotating Bolt	Tele/Fold 6-Position	Free-Float M-LOK	6.8	35.0	25.0	16.0	1:10	Timney Single-Stage	MPX	30
K	PMPX-4B-9	9mm	Semi-Auto	Gas Piston Rotating Bolt	Fixed Folding PCB	Free-Float M-LOK	5.8	21.3	13.5	4.5	1:10	Timney Single-Stage	MPX	30
COPPERHEAD	PMPX-3B-CH	9mm	Semi-Auto	Gas Piston Rotating Bolt	Telescoping PCB	N/A	4.5	14.5	N/A	3.5	1:10	MIL-SPEC	MPX	20
COPPERHEAD K	PMPX-4B-CH	9mm	Semi-Auto	Gas Piston Rotating Bolt	Telescoping PCB	N/A	4.8	15.5	N/A	4.5	1:10	Timney Single-Stage	MPX	20

716i TREAD



LIGHTWEIGHT BIG BORE AR PLATFORM

With a lightweight design and accuracy, the 716i has become one of the best known big bore AR's on the market today. Featuring an ambidextrous lower receiver, a precision carbon steel barrel, and a free-floating M-LOK® handguard, the 716i provides a versatile platform for long range shooting and hunting while maintaining a lightweight design for easy carry. Now available as part of the TREAD® rifle platform, the TREAD 716i is easily customizable with available TREAD accessories.

7.62x51NATO

FEATURES

- ▲ Free-floating M-LOK handguard
- ▲ Ambidextrous selector, mag release, and charging handle
- ▲ Ultralight design
- ▲ Adjustable Magpul® SL-K® stock
- ▲ Three prong flash hider

THE NEW FACE OF FREEDOM



LIGHTWEIGHT DESIGN



ADJUSTABLE MAGPUL® SL-K® STOCK



TREAD 16"

- ▲ Adjustable Magpul® SL-K® Stock
- ▲ Free-Floating M-LOK® Handguard
- ▲ 16" Precision Barrel

716i	SKU	Caliber	Action Type	Operating System	Stock Type	Forend Type	Weight w/Mag (lb)	Overall Length (in)	Collapsed Length (in)	Barrel Length (in)	Rifling	Trigger Type	Mag Type	Mag Capacity
TREAD 16"	R716i-16B-TRD	7.62x51 NATO	Semi-Auto	Direct Gas Impingement	6-Position Telescoping	Free-Float M-LOK	8.5	37.0	33.8	16.0	1:10	Hardened Polished	SR-25	20

M400 TREAD



THE NEW FACE OF FREEDOM

Introducing the new M400 TREAD from SIG SAUER®; all the features, all the freedom – none of the compromises. The TREAD is engineered to deliver exceptional quality and performance, and comes standard with the most sought-after features for today's AR platform rifles. Unlike most rifles in its class, the TREAD is easily customizable with a full line of purpose-built accessories. The TREAD from SIG SAUER – the new face of freedom.

5.56NATO

SHARED FEATURES

- ▲ Hard coat anodized upper and lower receiver
- ▲ Polished and Hardened Single-Stage Trigger
- ▲ Stainless steel barrel
- ▲ Free-floating M-LOK® handguard
- ▲ Magpul® SL-K® Telescoping Stock (Tread, Tread Coil, 16")
- ▲ Ambidextrous selector, mag release, and charging handle
- ▲ 30 round magazine

THE NEW FACE OF FREEDOM



ROME05® TREAD RED DOT SIGHT (COIL)



SIG MATCHLITE™ TRIGGER (COIL)



new

TREAD SNAKEBITE

- ▲ Cerakote® upper and lower receiver
- ▲ Enhanced 13" free-floating handguard
- ▲ Polished and hardened single-stage trigger
- ▲ Compatible with all TREAD accessories



TREAD COIL

- ▲ The most popular TREAD accessories factory installed
- ▲ 13" lightweight M-LOK® handguard
- ▲ Tread ROME05™ red dot
- ▲ SIG MATCHLITE™ Duo trigger



TREAD PISTOL 11"

- ▲ Polished and Hardened Single-Stage Trigger
- ▲ MAGPUL® BSL brace
- ▲ Free-Floating M-LOK® Handguard



TREAD 16"

- ▲ Polished and hardened single-stage trigger
- ▲ Magpul® SL-K® stock
- ▲ Free-floating M-LOK® handguard

STATE COMPLIANT MODELS AVAILABLE
RM400-16B-TRD-CA / RM400-16B-TRD-CO

M400	SKU	Caliber	Action Type	Operating System	Stock Type	Forend Type	Weight w/Mag (lb)	Overall Length (in)	Collapsed Length (in)	Barrel Length (in)	Rifling	Trigger Type	Mag Type	Mag Capacity
TREAD PISTOL	PM400-11B-TRD	5.56 NATO	Semi-Auto	Direct Gas Impingement	MAGPUL BSL Brace	Free-Float M-LOK	5.15	27.0	N/A	11.5	1:7	Single Stage	AR-15	30
TREAD SNAKEBITE	RM400-16B-TRD-SB	5.56 NATO	Semi-Auto	Direct Gas Impingement	6-Position Telescoping	Free-Float M-LOK	7.0	30.8	N/A	16.0	1:8	Single Stage	AR-15	30
TREAD COIL	RM400-16B-TRD-COIL	5.56 NATO	Semi-Auto	Direct Gas Impingement	6-Position Telescoping	Free-Float M-LOK	7.0	30.8	N/A	16.0	1:8	Matchlite	AR-15	30
TREAD 16"	RM400-16B-TRD	5.56 NATO	Semi-Auto	Direct Gas Impingement	6-Position Telescoping	Free-Float M-LOK	7.0	30.8	N/A	16.0	1:8	Single Stage	AR-15	30

TREAD

THE COMPLETE TREAD SYSTEM

PURPOSE-BUILT, CUSTOM ACCESSORIES THAT GIVE YOU THE FREEDOM TO GROW AND CUSTOMIZE



05
Three Chamber Compensator
Redirects gasses to reduce felt recoil.

06
15" Lightweight M-LOK® Handguard
Compatible with all M-LOK rail systems. Quickly move between TREAD free-float handguards by removing two screws.

* 13" Handguard - Standard on M400 TREAD COIL

03
Vertical Grip Kit
Multiple kits available for the freedom to customize your grip.

* Standard on M400 TREAD COIL

04
TREAD ROMEO5 OPTIC
2MOA dot with 10 illumination settings, MOTAC, and a 50k hour battery life.

* Standard on M400 TREAD COIL

02
Flip-Up, Back-Up Locking Iron Sights
Compatible with Picatinny rail systems. Tool less windage and elevation adjustment. Button less flip-up which locks in position.

07
Ambi-Charging Handle
Optimized for right or left-hand operation. Solid construction for prolonged use, and built for maintenance-free reliability.

01
Flat Blade Two-Stage Trigger
Vertical trigger profile for a precise feel, and crisp break for maximum performance.

* Standard on M400 TREAD® COIL

THE NEW FACE OF FREEDOM



Common TREAD Accessories to M400 and 716i



M400 TREAD Accessories



For a complete list of TREAD series accessories visit sigsauer.com

CROSS™ RIFLE



PRECISION HUNTING BOLT-ACTION RIFLE

Introducing the CROSS, a hybrid hunting/precision Crossover rifle which has redefined the traditional hunting rifle. Ultra-light, compact, and fully adjustable to the user, the CROSS sets a new standard for what the hunting rifle should be for the avid backcountry hunter.

.308WIN **6.5CREEDMOOR** **277SIG FURY**

SHARED FEATURES

- ▲ 2-stage match trigger
- ▲ Fully adjustable and foldable SIG precision Stock
- ▲ Free floating M-LOK® handguard
- ▲ One-piece aluminum receiver
- ▲ SIG match grade stainless barrel
- ▲ Removable top mounted picatinny rail
- ▲ Threaded, tapered muzzle
- ▲ Under 6.5 lbs, the lightest, most portable rifle in its class (up to 40% lighter)
- ▲ One-piece receiver for increased accuracy
- ▲ Available in .308 / 277 SIG FURY with an 16" barrel (collapsible to 25")
- ▲ Available in 6.5 Creedmoor with an 18" barrel (collapsible to 27")



FULLY ADJUSTABLE AND FOLDABLE SIG PRECISION STOCK



2-STAGE MATCH TRIGGER



CROSS™ RIFLE

- ▲ 2-stage match trigger
- ▲ Fully adjustable and foldable SIG precision stock
- ▲ Black anodized



CROSS RIFLE FIRST LITE® CIPHER

- ▲ 2-stage match trigger
- ▲ One-piece aluminum receiver
- ▲ First Lite Cipher finish

*SIERRA3BDX™ RIFLESCOPE SHOWN ON CROSS RIFLES NOT INCLUDED.

CROSS	SKU	Caliber	Action Type	Stock Type	Forend Type	Weight w/Mag (lb)	Overall Length (in)	Collapsed Length (in)	Barrel Length (in)	Rifling	Trigger Type	Mag Type	Mag Capacity
CROSS RIFLE	CROSS-308-16B / CROSS-277-16B / CROSS-65-18B	.308 / 277 / 6.5	Bolt	SIG Precision Stock	Free-Float M-LOK	6.5 / 6.8	36.5 / 38.5	25 / 27	16 / 18	1:10 / 1:8.5 / 1:9	2-Stage Match	AICS	5
FIRST LITE CIPHER	CROSS-308-16B-FLC / CROSS-277-16B-FLC / CROSS-65-18B-FLC	.308 / 277 / 6.5	Bolt	SIG Precision Stock	Free-Float M-LOK	6.5 / 6.8	36.5 / 38.5	25 / 27	16 / 18	1:10 / 1:8.5 / 1:9	2-Stage Match	AICS	5

AMMUNITION



SIG FURY™

FURY



Shot on location in the San Juan and Rio Grande National Forests, permission granted under special use authorization.

SIG FURY ACCUBOND® AMMUNITION

SIG FURY Hybrid case ammunition represents the biggest innovation in ammunition technology in more than 50 years, and now SIG SAUER® is pairing this revolutionary case design with the advanced Accubond bullet from Nosler®. SIG FURY Accubond hunting ammunition delivers increased speed and greater energy on target for maximum effectiveness.

FEATURES

- ▲ FURY hybrid case technology delivers greater velocity for increased on-target performance
- ▲ Utilizes the Nosler Accubond 150 grain big game bullet
- ▲ Hybrid case designed for greater energy transfer in shorter barrel length
- ▲ Loaded to exacting standards for consistency and reliability

REVOLUTIONARY HYBRID CASE AMMUNITION

Developed for the U.S. Military's Next Generation Weapons System, the new SIG FURY™ hybrid-case ammunition outperforms standard ammunition in similar calibers, with greater velocity, decreased bullet drop and increased energy on target. SIG FURY hybrid-case ammunition, the next generation of ammunition is here.



SIG FURY HYBRID CASE AMMUNITION. THE NEXT GENERATION OF AMMUNITION IS HERE.



new ACCUBOND® FURY HYBRID
H277SFAV150-20 277 SIG FURY 150GR



PERSONAL DEFENSE



JACKETED HOLLOW POINT PISTOL CARTRIDGES

SIG ELITE DEFENSE V-CROWN® defensive rounds combine perfected material specifications and fine-tuned design innovations. Featuring a stacked hollow point cavity, to deliver exceptional on-target energy, with maximum weight retention and optimal expansion for the ultimate in stopping power.

FEATURES

1. V-Shaped jacket with skives and scores to provide controlled, uniform expansion
2. Patented stacked hollow point bullet design with additional hollow point cavity
3. Unique, toothed cannellure ensures maximum weight retention and terminal expansion
4. Coated nickel cases provide enhanced lubricity, superior corrosion resistance, and reliable feeding and extraction
5. Low-flash propellant
6. Consistent primers

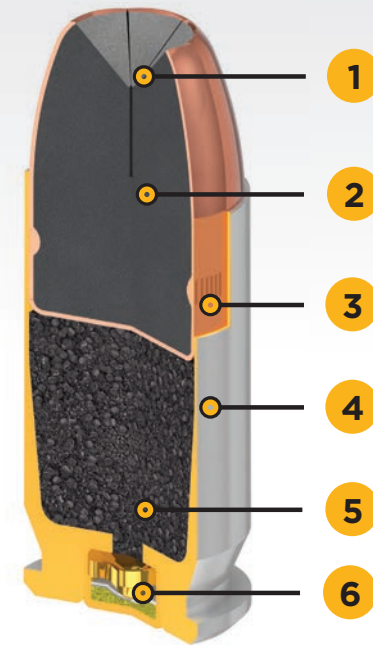

VCROWN 365
E9MMA1-365-20

ELITE DEFENSE

E10MM1-20 / E357M1-20 / E357S1-20 / E380A1-20 / E38SP1-20 / E38SU1-20 / E40SW1-20 / E40SW2-20 / E44MA1-20 / E44SP1-20 / E45APO-20 / E45API-20 / E45AP2-20 / E45LC1-20 / E9MMA1-20 / E9MMA2-20 / E9MMA3-20



*SIG SAUER V-CROWN is optimized for maximum terminal ballistic performance when used in short-barreled firearms.

RANGE/TRAINING



PERFORMANCE TRAINING AMMUNITION

SIG SAUER® full metal jacket cartridges are engineered to deliver maximum performance so you can train harder with greater accuracy and reliability. Produced with the cleanest burning powders, premium brass cases and the most consistent primers available.

FEATURES

1. Full metal jacket projectiles ballistically matched to ensure the same point-of-impact as personal defense and duty ammunition
2. Lead core
3. Precision manufactured brass cartridge cases
4. Clean burning powders
5. Consistent primers



FMJ PISTOL

E10MB1-50 / E357B1-50 / E357MB-50 / E380B1-50 / E385B1-50 / E38SUB-50 / E40SB2-50 / E45BA3-50 / E9MMB1-50 / E38SB2-50 / E9MMB3-50 / E9MMLF51-50

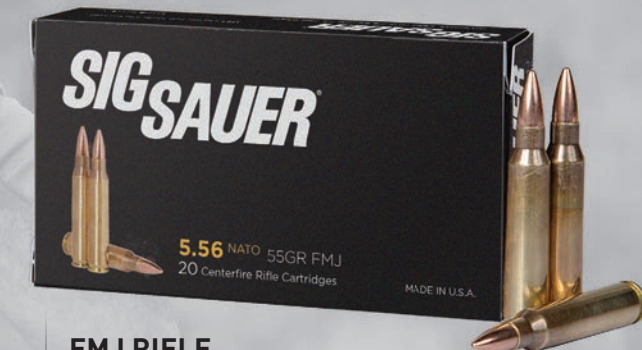

FMJ RIFLE

5.56NATO / 223 REM / 300 BLK / 308 WIN
E556B1-20 / E223B1-20 / E300B1-20 / E308B1-20



*Optimized for maximum performance when used in short-barreled firearms.

MATCH GRADE



PRECISION MATCH GRADE RIFLE CARTRIDGES

SIG Marksman and Marksman Elite rifle cartridges are engineered to excel in today's precision auto-loading platforms, as well as bolt-action rifles. Utilizing optimized shell case metallurgy and premium primers, each round is precision-loaded using state-of-the-art, electromechanical monitoring for geometric conformity, and all are 100% inspected.

FEATURES

1. Open tipped match designed to maximize BC
2. Thin jacket design for precise concentricity
3. Bullet weights are held within +/- 0.3 grains
4. Temperature-stable propellants
5. Brass cases are 100% inspected and lot controlled
6. Industry leading primers are unmatched in power and performance

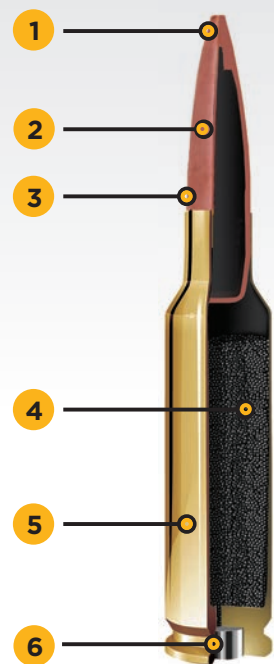

MARKSMAN
E223M1-20 / E556M4-20 / E300A1-20 / E300A2-20



MARKSMAN ELITE
E308M1-20 / E308M2-20 / E308M3-20 / E3WMM1-20 / E65CM1-20 / E260M2-20 / E3006M2-20 / E6MMCM2-20

- ▲ Minimal Velocity Variation
- ▲ Precision Loaded for Conformity
- ▲ Renowned Sierra® Matchking® Projectile
- ▲ Temperature-Stable Propellants



COMPETITION



COMPETITIVE PISTOL CARTRIDGES

SIG Match Elite Competition loads have been designed in conjunction with Team SIG, for the serious competitive shooter who needs an accurate and completely reliable competitive round. Currently offered in a 9mm, 115 and 147 grain projectile and loaded in a premium nickel case for improved function and feeding. The round utilizes a reduced charge weight with a fast-burning powder, so felt recoil has been reduced significantly for improved accuracy, better gun control, and higher scores.

FEATURES

1. V-Shaped jacket with skives and scores to provide controlled, uniform expansion
2. Patented stacked hollow point bullet design with additional hollow point cavity
3. Unique toothed cannellure ensures maximum weight retention and terminal expansion
4. Coated nickel cases provide enhanced lubricity, superior corrosion resistance, and reliable feeding and extraction
5. Low-flash propellant
6. Consistent primers

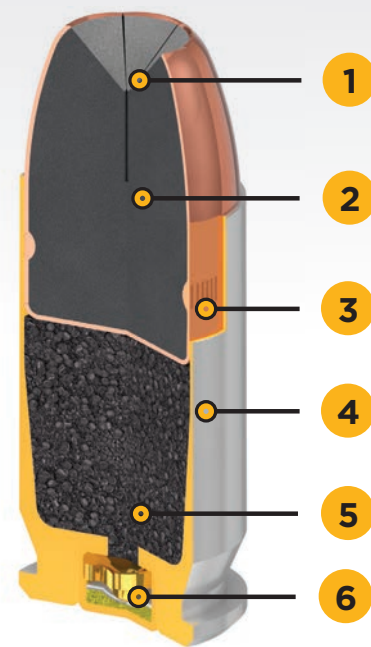

MATCH ELITE 115GR

JHP 9MM
E9MMA1-COMP-50



9MM LUGER
115 grain



9MM LUGER
147 grain

*When measured from Max Michel's match pistol



MAX MICHEL CAPTAIN TEAM SIG

"As a World Champion competitive shooter, I want and need the best. Therefore, I wanted to create a load that was soft shooting, yet clean, consistent and extremely accurate. We found that with our 147gr V-Crown projectile, nickel casing and match propellant. Together, the folks at the SIG SAUER Ammunition and Team SIG have created a round that is extremely accurate, clean and consistent. I couldn't be prouder to have been a part of such a successful product. When the 9mm 147gr Match Elite is fueling my X5 Legion, I truly feel there is no better combo out there and it gives me a clear advantage on the range."



TIPPED LEAD CORE HUNTING CARTRIDGES

SIG SAUER® ELITE SERIES TIPPED ammunition gives the serious sportsman unmatched, long-range accuracy, with devastating on-target performance. Massive expansion delivers instant knockdown and terminal energy on small to medium game.

FEATURES

1. Translucent yellow tip increases ballistic coefficient, improves terminal performance, and aids in consistent reliable chambering
2. Exclusive jacket design delivers devastating on-game performance for small to medium game at extended ranges
3. Concentric, blackened jacket ensures reliable expansion
4. Enhanced boat tail design provides superior flight characteristics over a wide range of velocities
5. Custom formulated and precision loaded powders deliver consistent velocities regardless of atmospheric conditions
6. Nickel-plated cases aid in extraction while providing significant anti-corrosion qualities
7. Industry leading primers are matched to proprietary powder blends to ensure dependable ignition

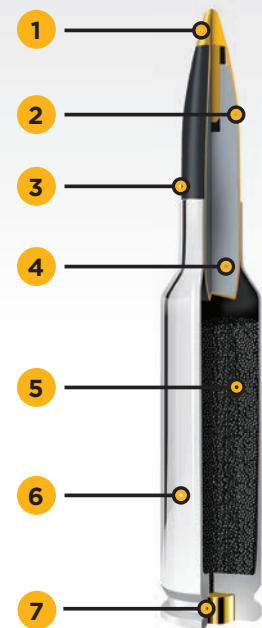

ELITE SERIES TIPPED

E243TH2-20 / E270TH2-20 / E3006TH2-20 / E308TH2-20 / E3WMTH3-20 / E65CMTH1-20 / E6MMCTH2-20 / E7RMTH2-20 / E300H1-SBR-20



HUNTING



ACCUBOND® HUNTING CARTRIDGES

SIG SAUER® ELITE HUNTER TIPPED ammunition gives the serious sportsman unmatched, long-range accuracy, with devastating on-target performance. Massive expansion delivers instant knockdown and terminal energy on small to medium game.

FEATURES

1. Unique white polymer tip assures accuracy, smooth chambering and eliminates tip damage during recoil
2. Tapered copper-alloy jacket for lethal penetration and uniform expansion with maximum weight-retention and minimal barrel fouling
3. Proprietary bonding process eliminates all possibility of component separation
4. Lead-alloy core engineered for balanced expansion
5. Boat-Tail Design configuration combines with the streamlined polymer tip for long-range performance and for easier loading
6. Custom formulated and precision loaded powders deliver consistent velocities regardless of atmospheric conditions
7. Nickel-plated cases aid in extraction while providing significant anti-corrosion qualities
8. Industry leading primers are matched to proprietary powder blends to ensure dependable ignition

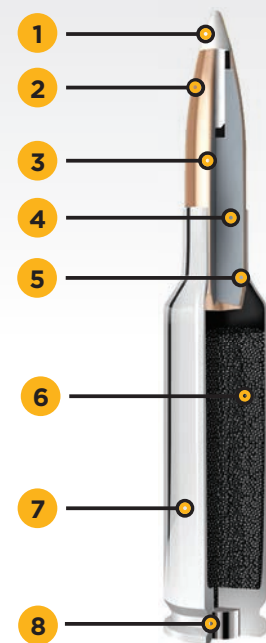

ELITE SERIES ACCUBOND®

E243TH2-20 / E270TH2-20 / E3006TH2-20 / E308TH2-20 / E3WMTH3-20 / E65CMTH1-20 / E6MMCTH2-20 / E7RMTH2-20 / E300H1-SBR-20



HUNTING



SOLID COPPER HUNTING CARTRIDGES

SIG ELITE SERIES COPPER rounds use premium-quality powders and primers for minimum velocity variation, and yield a 1.8x diameter expansion. Perfected for easy rifle feeding, with an optimized nose geometry, and premium nickel-plated shell casings that deliver consistently reliable accuracy for taking down game.

FEATURES

1. Optimized nose geometry for easy rifle feeding
2. Consistent 1.8X diameter expansion
3. Lead-free monolithic copper bullet
4. Proprietary powder blends to ensure dependable ignition
5. Premium nickel-plated shell casings that deliver consistently reliable accuracy for taking down game
6. Industry leading primers are matched to proprietary powder blends to ensure dependable ignition



ELITE SERIES COPPER

E223HI-20 / E308HI-20 / E300HI-20 / E65CHI-20/ E3WMHI-20 / E6MMCHI-20 / E260HI-20 / E270HI-20 / E243HI-20 / E3006HI-20





ELITE SERIES VARMINT & PREDATOR CARTRIDGES

SIG Elite Series Varmint & Predator rounds utilize yellow tipped projectiles designed specifically for explosive expansion and unmatched accuracy. All loads feature projectiles yielding higher muzzle velocities and aerodynamic bullet designs to maximize flat trajectory.

FEATURES

1. Yellow tip increases ballistic coefficient, improves terminal performance, and aids in consistent reliable chambering
2. Jacketed lead-core bullet designed for explosive fragmentation and quick take-down on varmints
3. Custom formulated and precision loaded powders deliver consistent velocities regardless of atmospheric conditions
4. Brass cases aid in extraction while providing significant anti-corrosion qualities
5. Industry leading primers are matched to proprietary powder blends to ensure dependable ignition



ELITE SERIES VARMINT & PREDATOR

E223V1-20 / E225V1-20 / E243V1-20 / E223V2-20



223 REM
40 grain
55 grain

22-250 REM
40 grain

243 WIN
55 grain

300 BLK
205 grain
TIPPED



300 HAM'R®
E300HAMRPH1-20 E300HAMRPH1-20 300 HAMMER 125GR SPT
E300HAMRHC1-20 E300HAMRHC1-20 300 HAM'R, 130GR, SOFT POINT

COMPONENTS



338 NORMA MAG
BAGGED BRASS



9MM
Primed Bagged Brass

6.5 CREEDMOOR
Bagged Brass

338 NORMA MAG
Bagged Brass

BAGGED BRASS / PRIMED BAGGED BRASS

Elite Performance Ammunition shell cases are engineered to exacting tolerances and available for multiple pistol and rifle calibers. The geometric consistency of these premium brass cases ensures each primer is held tightly in its pocket. Flash holes are precise with no burrs and the superior metallurgical properties of the SIG SAUER® cases enable repeated reloading. All Elite Performance rifle shell cases are induction annealed for consistent bullet retention.

THE BEST RELOADING BRASS
MANUFACTURED IN THE U.S.A.

FEATURES

1. Engineered for precision hand loaders
2. Exceptional concentricity of the mouth for improved accuracy
3. Engineered to exacting standards; each brass case undergoes rigorous in-line and post-production quality assurance testing to ensure a flawless casing
4. Flash holes are precise with no burrs
5. Superior metallurgical properties of the SIG SAUER® cases enable repeated reloading
6. SIG Elite rifle shell cases are induction annealed for consistent bullet retention
7. All shell cases are 100% inspected by advanced metrology equipment that measures every dimensional aspect of the case.



UN-PRIMED

CALIBER	QTY/BAG	SKU
380 AUTO	100	BP1002
9MM	100	BP1003
357 SIG	100	BP1005
38 SPL	100	BP1007
357 MAG	100	BP1008
40 S&W	100	BP1009
10MM	100	BP1010
45 AUTO	100	BP1011
223 REM	100	BR2004
22-250 REM	50	BR2005
243 WIN	50	BR2006
6MM CM	50	BR6MMCM
6.5 CM	50	BR2011
260 REM	50	BR260REM
270 WIN	50	BR2018
7MM REM	50	BR2024
300 BLK	50	BR2029
308 WIN	50	BR2030
30-06 SPG	50	BR2031
300 WIN MAG	50	BR2033
338 NORMA	25	BR338NM

PRIMED

CALIBER	QTY/BAG	SKU
380 AUTO	100	BP1002P
9MM	100	BP1003P
357 SIG	100	BP1005P
38 SPL	100	BP1007P
357 MAG	100	BP1008P
40 S&W	100	BP1009P
10MM	100	BP1010P
45 AUTO	100	BP1011P



ELECTRO-OPTICS



ELECTRO-OPTICS



SIG SAUER® ELECTRO-OPTIC INFINITE GUARANTEE™

- Unlimited Lifetime Guarantee
- No Warranty Card Required
- No Receipt Required
- No Time Limit Applies
- No Charge
- Fully Transferable



ELECTRONIC AND TRITIUM LIMITED 5-YEAR WARRANTY

Covers any defects in materials and workmanship in the electronic and tritium components of illuminated riflescopes/sights, pistol sights, electronic sights, flashlights, lasers, binoculars, spotting scopes, and rangefinders for five years from the date of manufacture.

EMBEDDED APPLIED BALLISTICS®

ABU™ Applied Ballistics Ultralight™

Applied Ballistics Ultralight is the streamlined ballistic calculator developed with Applied Ballistics and integrated into all BDX® products. Ballistic solutions are provided out to a maximum of 800 yards.

ABX Applied Ballistics External

Applied Ballistics External allows external devices such as a Kestrel or Garmin Foretrex to compute AB Elite solutions and communicate the firing solution back to select BDX enabled devices.

ABS™ Applied Ballistics System

Applied Ballistics System embeds Applied Ballistics Elite on-board select products with integral environmental sensors to calculate complete ballistic solutions out to the effective range of any firearm.



D.A.R.C.

(Dark Adaptive Reticles & Coatings) Specialized lens coatings and reticle brightness settings that are optimized for use with GEN 3+ night vision devices



MAGNETAC™

MAGNETAC (Magnetic Activation) A sensor in the optic detects a Neodymium magnet inside a compatible holster, to automatically turn the optic off when holstered, conserving battery life. When the weapon is drawn from the holster, the optic instantly turns on to the last setting used.



SBT™ SIG Ballistic Turret

A custom, laser-etched elevation dial on most SIG SAUER® TANGO® and WHISKEY® riflescopes

Matched to the ballistics of the shooter's system at no extra cost

Inputs bullet specifications, ballistic coefficient, muzzle velocity, elevation, and other environmental factors

Allows for correct bullet drop compensation and pinpoint accuracy at any range



LOCKDOWN™ Zero System

Zero stop-locking turret allows a rapid return to zero

Eliminates concern about how far to turn the elevation dial to return to zero



STEALTH ID™

Deflection armor trapezoidal surfacing breaks up the shape and visibility of the optic

Slide serrations and grip checkering add function to the form of all SIG SAUER Electro-optics



HELLFIRE™ Reticle

Electronically illuminated utilizing an advanced fiber optic technology

Varies the light intensity of the central aiming point from night vision compatible to HELLFIRE bright for daylight illumination

Results in a bright, defined aiming point for precision shot placement in any condition



LEVELPLEX® Digital Anti-Cant System

Utilizes an Integrated Digital Level that is Accurate to +/- 0.5° Available in any WHISKEY5 or TANGO6 with a side focus

Auto LEVELPLEX Mode Calibrates Level Sensitivity to Distance Ranged to Target



MEGAVIEW™

Provides massive field of view (FOV), allowing faster target acquisition

Enhances awareness of objects in the shooter's periphery



ALT™ Aspheric Lens Technology

Eliminates aberration, reduces weight, and helps to focus the projected image through the lenses

Superior low distortion optical performance



SPECTRACOAT™

Highly efficient, ultra-wide broadband, anti-reflection lens coatings

Reduces surface reflections to extremely low levels across the entire visible spectrum

Provides superior light transmission



HDX™ High Definition Transmittance

Comprises both high definition (HD) and high transmittance (HT) glass

Ultra-high resolution, optical performance, and light transmission



LENSARMOR™

Abrasion-resistant lens coatings

Extreme durability ensures the lenses on the scope will stay sharp, bright, and clear



LENSHIELD™

Mil-spec oleophobic coating

Sheds water, oil, and gunk, to ensure a clean sight image at all times



MOTAC™ Moton Activated Illumination

Motion-sensing technology

Powers up illumination when sensing motion, and powers down when it does not, extending battery life



SOLAR POWERED ILLUMINATION

Powered by a solar cell

Extends runtime and improves daylight brightness of the reticle with or without a battery



TRUHold™

Lockless zeroing system

Utilizes quad adjustment springs designed and torture-tested to endure handgun recoil and return to zero shot after shot



OIS Optical Image Stabilization

Proprietary SIG optical image stabilizer system

Gyroscopically stabilized to cancel out unwanted shaking and vibrations that can blur an image, especially at higher magnification levels



AMR™ Angle-Modified Range

Ranging technology using an on-board inclinometer

Reads incline / decline angle and modifies the effective ballistic shooting range to the target

Equivalent horizontal range, that integrates perfectly when used with SIG ballistic turret dials



LIGHTWAVE DSP™ Digital Signal Processing

Leverages HyperScan, and advanced power management technique, providing the fastest refresh rate in scan mode (4 times per second)

Uses the latest generation field programmable gate array (FPGA)

Reduces false positives while finding weak or distant targets



HYPERSCAN™

Features the fastest, most accurate range acquisition algorithms by analyzing targets 4 times per second and displaying the results on stationary or moving targets within a quarter of a second.



LUMATIC OLED DISPLAY

Proprietary OLED (Organic Light Emitting Diode) display ambient light sensor continuously monitors light conditions and adjusts the display brightness accordingly

No other display offers this adaptive ability to prevent the shooter's pupil from constricting in low-light conditions

90° POWERCAM™ MOUNT

Quick flip away mount for fast transitions from near to far distance targets

No button actuator for rapid single-handed operation point for precision shot placement in any condition



KinETHIC™ Kinetic Energy Indicator

KinETHIC Kinetic Energy Indicator

Allows a hunter to set a threshold in either ft-lbs or fps for the ethical harvest of game animals. BDX will compute distance ranged and indicate when you drop below the user-set threshold for energy or speed of bullet on target

BDX™ 2.0

Software update that includes a new easy mode for quick BDX setup out of the box, including:

BDX kits come paired and bonded

BDX QuickBond™ system gives users the ability to bond two BDX enabled devices without the smartphone app

BDX equipped KIL0® rangefinders preloaded with ballistic groups for centerfire rifles, muzzleloaders, and crossbows

100% compatible with BDX smartphone app to access the advanced BDX features in configuration options



WEAPONSGRADE Polymer

Optimized for use with polymer pistols

Lightweight textured polymer



Ballistic Data Xchange



Powered by



WHAT IS BDX?

SIG SAUER[®] has built on the success of BDX, adding features and benefits that allow hunters and shooters to 'hit the ground running' with their BDX systems. All BDX rangefinders now come preprogrammed with 9 ballistic profiles that cover most centerfire rifle cartridges, as well as crossbows and muzzleloaders. BDX combo kits will now come pre-bonded from the factory. All users have to do to use their systems now is mount and zero their riflescopes. If users want to unlock the complete feature set of BDX, they are still able to do this via the smartphone app.

BDX RANGEFINDER

BDX kits come pre-bonded right out of the box

When purchasing a rangefinder and riflescope together there is no setup necessary. Simply mount and zero your riflescope and you are ready to go.

QuickBond™ for app-less bonding of BDX equipped rangefinders and sights

There is no need for the smartphone app to connect your BDX devices. Simply press and hold two buttons and your BDX rangefinder will bond with the nearest BDX enabled sight.

Pre-loaded ballistic groups now available on KILO[®] BDX rangefinders to quickly get you on target

Every BDX rangefinder now comes preloaded with 9 distinct ballistic groups. These groups represent the ballistics for each popular centerfire caliber available, as well as crossbows and muzzleloaders. Simply pick the group that matches your caliber.

Download the BDX app to unlock the full advanced capabilities and features of the BDX system

Setup a custom profile utilizing the Applied Ballistics[®] bullet library and the exact muzzle velocity of your firearm. BDX will do the rest.

BDX RIFLESCOPE

The powerful SIERRA3BDX and SIERRA6BDX riflescopes revolutionize the art of holdover calculation. Again, set your ballistic profile in the SIG BDX app, sync the app with your riflescope and then configure multiple holdover points in the digital ballistic reticle. When you view your target through the reticle each of your exact holdover points is illuminated. No more turrets to adjust or calculations to make.

BDX SYSTEMS

When used together, KILO BDX rangefinders and SIERRA3BDX riflescopes combine to create the most advanced optics system available on the market today. Simply configure your ballistics profile in the BDX app, pair your KILO BDX rangefinder with the app, and then bond it to your SIERRA3BDX riflescope. When you range your target the KILO BDX rangefinder automatically sends your specific holdover data to your SIERRA3BDX riflescope giving you an illuminated holdover dot. It's simple and fast.

CONNECT THE DOT[®].

Learn more about the BDX System at sigsauer.com/electro-optics

THE WORLD'S MOST ADVANCED...

RIFLESCOPES

- ▲ BDC reticle is customized to shooter's ballistics and environmental profile prior to hunting
- ▲ BDC reticle can be set with up to eight holdover dots at any distances out to 800 yards
- ▲ Digital Focal Plane™ reticle scales with zoom like a first focal plane riflescope
- ▲ HD Glass and Spectracoat™ lens coatings
- ▲ LEVELPLEX[®] digital anti-cant system



RANGEFINDERS

- ▲ Embedded Applied Ballistics[®] Ultralite engine with extensive bullet library with support for G1/G7 drag curves
- ▲ Save up to 25 custom ballistic profiles in the SIG BDX app
- ▲ Active ballistic profile and environmental sync to rangefinder
- ▲ Windage and elevation holds in MOA or MILS with every target ranged
- ▲ Lightwave DSP™ leverages 4x/second HyperScan™ and RangeLock technologies for the fastest ranging performance



OPTICS SYSTEM

SIG SAUER[®] Electro-Optics transforms hunting with the unprecedented simplicity and accuracy of BDX[®]. KILO[®] BDX rangefinders use your ballistics and Bluetooth[®] to illuminate the exact holdover dot in SIERRA3BDX riflescopes. For the most accurate and ethical shot, just **CONNECT THE DOT[®]**.





RIFLESCOPES WITH BALLISTIC DATA XCHANGE

Built upon SIERRA3 award-winning technology, and the SIG SAUER® BDX Ballistic Data Xchange technology, the SIERRA6 family of riflescopes provides the hunter or marksmen with an intelligent auto-holdover specific to their ballistics, target, and environment. Pairing a SIERRA6 to a BDX equipped rangefinder allows users to bring the capability of Applied Ballistics® into the field without the need for a mobile device.

30mm Maintube **34mm Maintube**

SHARED FEATURES

- ▲ Blue LED on eye piece indicates when Bluetooth® is paired to KILO® BDX rangefinder
- ▲ HDX® glass and coatings for the best optical quality in its class integrated BDX ballistic data xchange 2.0 with up to 95% light transmission
- ▲ Advanced HDX 6x optical system
- ▲ Automatic hold-over dot on a digital focal plane
- ▲ Ballistic profiles compatible with centerfire, muzzle loader, and crossbow platforms
- ▲ Innovative KinETHIC™ Kinetic energy transfer indicator for ethical shots
- ▲ Dependable waterproof and fog-proof performance (IPX-7 for complete immersion up to 1 Meter)
- ▲ Argon purged for an enhanced lifetime of performance
- ▲ LEVELPLEX® with auto LEVELPLEX mode



Ballistic Data Xchange



BLUE LED FLASHES WITH EACH RETICLE UPDATE



SIDE FOCUS ALLOWS USERS TO REMOVE PARALLAX



ADVANCED HDX 6X OPTICAL SYSTEM



SIERRA6BDX™ 5-30X56

SOSBDX65111

- ▲ 34mm maintube
- ▲ Digital focal plane BDX-R2 reticle
- ▲ Seamlessly pairs with BDX enabled devices to provide exact holdovers based on measured target distances
- ▲ User-customizable ballistic data provides hold-over dots
- ▲ Side focus allows users to remove parallax

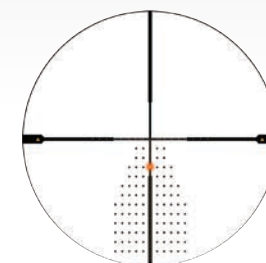

The BDX-R2 Digital Ballistic Reticle GEN II High Resolution LED display doubles the amount of available hold-over dots giving users greater accuracy and resolution to each shot. The reticle has aiming aids to help align elevation and wind indicators.



SIERRA6BDX 3-18X44

30MM MAINTUBE
SOSBDX63111

- ▲ 30mm maintube
- ▲ Digital focal plane BDX-R2 reticle
- ▲ Seamlessly pairs with BDX enabled devices to provide exact holdovers based on measured target distances
- ▲ User-customizable ballistic data provides hold-over dots
- ▲ Side focus allows users to remove parallax



SIERRA6BDX 2-12X40

30MM MAINTUBE
SOSBDX62111

- ▲ 30mm maintube
- ▲ Digital focal plane BDX-R2 reticle
- ▲ Seamlessly pairs with BDX enabled devices to provide exact holdovers based on measured target distances
- ▲ User-customizable ballistic data provides hold-over dots

SIERRA3BDX™



RIFLESCOPIES WITH BALLISTIC DATA XCHANGE

Disguised within the form factor of a traditional riflescope lies the power of the SIG SAUER® BDX Ballistic Data Xchange. The SIERRA3BDX riflescope provides the hunter with an illuminated auto-holdover dot on targets when coupled with a BDX-capable KILO® rangefinder.

30mm Maintube

SHARED FEATURES

- ▲ Integrated BDX Ballistic Data Xchange 2.0
- ▲ Automatic holdover dot on a digital focal plane
- ▲ Ballistic profiles compatible with center-fire, muzzle-loader, and crossbow platforms
- ▲ Innovative KinETHIC™ kinetic energy transfer indicator
- ▲ Dependable waterproof and fog-proof performance (IPX-7 for complete immersion up to 1 meter)
- ▲ LEVELPLEX® with auto LEVELPLEX mode
- ▲ Provides holdover dot for hunting out to 800 yards
- ▲ Digital focal plane BDX-R1 reticle sub-tensions correct with zoom
- ▲ Blue LED on power selector indicates when Bluetooth® is paired to KILO BDX rangefinder
- ▲ HD Glass and coatings for the best optical quality in its class



Ballistic Data Xchange



BLUE LED FLASHES WITH EACH RETICLE UPDATE



SIDE FOCUS ALLOWS USERS TO REMOVE PARALLAX



ADVANCED HD 3X OPTICAL SYSTEM



SIERRA3BDX™ 6.5-20X52

SOSBDX36111

- ▲ Provides holdover dot for hunting out to 800 yards
- ▲ Digital focal plane BDX-R1 reticle subtends with zoom
- ▲ Blue LED on power selector Indicates when Bluetooth is paired to KILO BDX rangefinder
- ▲ Side focus allows users to remove parallax
- ▲ 30mm maintube

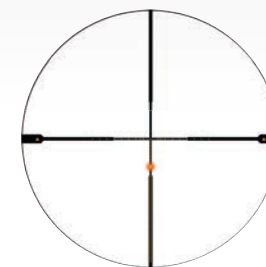

The BDX-R1 Digital Ballistic Reticle



SIERRA3BDX 4.5-14X50

30MM MAINTUBE
SOSBDX34112

- ▲ Provides holdover dot for hunting out to 800 yards
- ▲ Digital focal plane BDX-R1 reticle subtends with zoom
- ▲ Side focus allows users to remove parallax



SIERRA3BDX 4.5-14X44

30MM MAINTUBE
SOSBDX34111

- ▲ Provides holdover dot for hunting out to 800 yards
- ▲ Digital focal plane BDX-R1 reticle subtends with zoom
- ▲ Side focus allows users to remove parallax



SIERRA3BDX 3.5-10X42

30MM MAINTUBE
SOSBDX33111

- ▲ Provides holdover dot for hunting out to 800 yards
- ▲ Digital focal plane BDX-R1 reticle subtends with zoom



SIERRA3BDX 2.5-8X32

30MM MAINTUBE
SOSBDX32111

- ▲ Provides holdover dot for hunting out to 800 yards
- ▲ Digital focal plane BDX-R1 reticle subtends with zoom

KILO3000BDX™



BDX® BALLISTIC DATA XCHANGE LASER RANGEFINDER

Featuring SIG SAUER® BDX® technology, the KILO3000BDX is one of the world's most advanced laser rangefinders. When paired with a BDX enabled product, the onboard Applied Ballistics Ultralight™ calculator sends ballistic drop data via Bluetooth® directly to the BDX sight, providing an illuminated holdover dot and wind hold. Download the free BDX App for iOS or Android to setup ballistic profiles and synchronize custom profiles to your KILO® for exact ballistic solutions.

10X42mm

FEATURES

- ▲ HyperScan™ technology provides 4 range updates per second in scan mode while RangeLock™ reports the last range result when ranging distant targets
- ▲ Embedded Applied Ballistics Ultralight with bullet database and support for G1/G7 drag curves
- ▲ Fully multi-coated ED glass lenses and phase-coated prisms for high resolution and high contrast will range up to 5,000 yards with results displayed to the nearest 1/10th yard
- ▲ Lumatic OLED display, continuously monitors light conditions & adjusts the display brightness accordingly
- ▲ Multi-position twist-up eyecups provide a custom fit for each user
- ▲ Compact, lightweight aluminum housing with dual diopter adjustment
- ▲ User-selectable target modes featuring LAST or BEST mode for pinpoint accuracy



Ballistic Data Xchange



USER-SELECTABLE TARGET MODE



MULTI-POSITION TWIST-UP EYECUPS



FULLY MULTI-COATED ED GLASS LENSES



KILO3000BDX™ BINOCULAR RANGEFINDER

SOK31001

- ▲ BDX® Ballistic Data Xchange capable, providing your BDX riflescope with an automatic illuminated holdover dot through Bluetooth® pairing
- ▲ Supports Applied Ballistics® external for pairing to a Kestrel® or Garmin® running AB Elite®
- ▲ Revolutionary Lightwave DSP™ technology for the fastest and longest distance rangefinder engine
- ▲ Powered by a lithium CR2 battery
- ▲ FOV = 32 ft/100 yards / 6.1 degrees



KILO3000BDX Display

Will range up to 5,000 yards with results displayed to the nearest 1/10th yard

RANGES	Up to 2000 YDS DEER	Up to 4000 YDS TREES	Up to 5000 YDS REFLECTIVE
--------	---------------------	----------------------	---------------------------

Powered by:



2019 INDUSTRY CHOICE AWARDS

Optic of the Year: KILO3000BDX Rangefinder Binoculars



BDX® LASER RANGEFINDER

Featuring SIG SAUER® BDX® technology, the KILO® BDX series of rangefinders are the world's most advanced laser rangefinders. When paired with a BDX enabled product, the onboard Applied Ballistics Ultralight™ calculator sends ballistic drop data via Bluetooth® directly to the BDX sight, providing an illuminated holdover dot and wind hold. Download the free BDX App for iOS® or Android® to setup ballistic profiles and synchronize custom profiles to your KILO for exact ballistic solutions.

17X25mm

SHARED FEATURES

- ▲ BDX® Ballistic Data Xchange capable. Providing your BDX riflescope with an automatic, illuminated holdover dot through Bluetooth pairing
- ▲ Embedded Applied Ballistics Ultralight with bullet database and support for G1/G7 drag curves
- ▲ Supports Applied Ballistics external for pairing your KILO® with a Kestrel® with onboard Applied Ballistics Elite
- ▲ Low Energy Bluetooth 4.0 for Synchronizing up to 25 Custom ballistic profiles between the free SIG ballistic App and rangefinder
- ▲ Advanced OLED display provides a smaller, extremely precise targeting circle along with milling features and ballistic info including holdover angle, target mode, and shot angle
- ▲ 4x per second scan rate
- ▲ Low-energy Bluetooth®
- ▲ User-selectable target modes featuring LAST or BEST mode for pinpoint accuracy
- ▲ Powered by lithium CR2 battery



Ballistic Data Xchange



4X PER SECOND SCAN RATE



USER-SELECTABLE TARGET MODES



BDX BALLISTIC DATA XCHANGE CAPABLE



RANGES	Up to 1400 YDS DEER	Up to 1800 YDS TREES	Up to 3400 YDS REFLECTIVE
--------	---------------------	----------------------	---------------------------

KILO2400BDX™ BINOCULAR RANGEFINDER

SOK24704

- ▲ BDX® Ballistic Data Xchange capable, providing your BDX riflescope with an automatic illuminated holdover dot through Bluetooth® pairing
- ▲ Embedded Applied Ballistics Ultralight™ with bullet database and support for G1/G7 drag curves
- ▲ Supports Applied Ballistics external for pairing your KILO® with a Kestrel® with onboard Applied Ballistics Elite



DISPLAY

KILO2200BDX™

SOK22704



RANGES	Up to 1300 YDS DEER	Up to 1600 YDS TREES	Up to 3400 YDS REFLECTIVE
--------	---------------------	----------------------	---------------------------



KILO1800BDX™

SOK18601 (CLASS 3R)



RANGES	Up to 1000 YDS DEER	Up to 1200 YDS TREES	Up to 2000 YDS REFLECTIVE
--------	---------------------	----------------------	---------------------------



KILO1600BDX™

SOK16607



RANGES	Up to 1000 YDS DEER	Up to 1200 YDS TREES	Up to 2000 YDS REFLECTIVE
--------	---------------------	----------------------	---------------------------



KILO1000BDX™

SOK10602



RANGES	Up to 800 YDS DEER	Up to 1000 YDS TREES	Up to 1200 YDS REFLECTIVE
--------	--------------------	----------------------	---------------------------



BDX 2.0™ COMBO KITS



BDX® BALLISTIC XCHANGE SYSTEMS

Ultimate BDX value kits come with SIERRA3BDX riflescope and a KILO® BDX rangefinder. Simply download the SIG BDX App, set up your ballistic profile, pair your new BDX rangefinder and riflescope, and go hunt.

30mm Maintube

BDX 2.0 COMBO KIT FEATURES

- ▲ BDX Ballistic Data Xchange capable. Providing your BDX riflescope with an automatic illuminated holdover dot through Bluetooth® Pairing
- ▲ Embedded Applied Ballistics Ultralight™ with bullet database and support for G1/G7 drag curves
- ▲ Supports Applied Ballistics external for pairing your KILO rangefinder with a Kestrel® with onboard Applied Ballistics Elite
- ▲ Low energy Bluetooth 4.0 for synchronizing up to 25 custom ballistic profiles between the free SIG ballistic app and rangefinder
- ▲ Advanced OLED display information. provides a smaller, extremely precise targeting circle, along with milling features and ballistic info, including holdover angle, target mode, and shot angle



Ballistic Data Xchange



BLUE LED FLASHES WITH EACH RETICLE UPDATE



USER-SELECTABLE TARGET MODES



BDX BALLISTIC DATA XCHANGE CAPABLE

SIERRA3BDX™ 6.5-20X52

SOK24BDX01

- ▲ Provides holdover dot for hunting out to 800 yards
- ▲ Digital focal plane BDX-R1 reticle subtends with zoom
- ▲ Blue LED on power selector indicates when Bluetooth is paired to KILO BDX rangefinder
- ▲ HD glass and coatings for the best optical quality in its class
- ▲ Integrated BDX® Ballistic Data Xchange
- ▲ Automatic holdover dot on a digital focal plane
- ▲ Innovative KinETHIC™ kinetic energy transfer indicator



RETICLE

SIERRA3 BDX
6.5-20X52
Reticle



Powered by:



RANGES

Up to
1400 YDS
DEER

Up to
1800 YDS
TREES

Up to
3400 YDS
REFLECTIVE

KILO2400BDX™ RANGEFINDER

SOK24BDX01

- ▲ BDX Ballistic Data Xchange capable. Providing your BDX riflescope with an automatic illuminated holdover dot through Bluetooth® pairing
- ▲ Embedded Applied Ballistics Ultralight™ with bullet database and support for G1/G7 drag curves
- ▲ Supports Applied Ballistics external for pairing your KILO® rangefinder with a Kestrel® with onboard Applied Ballistics Elite
- ▲ Low energy Bluetooth® 4.0 for synchronizing up to 25 custom ballistic profiles between the free SIG ballistic app and rangefinder
- ▲ Advanced OLED display information. Provides a smaller, extremely precise targeting circle along with milling features and ballistic info including holdover angle, target mode, and shot angle



DISPLAY

KILO2400BDX
Display



SOK16BDX61

COMBO KITS

KILO1600BDX /
SIERRA6BDX 2-12X40
SOK16BDX61

KILO2200BDX /
SIERRA6BDX 3-18X44
SOK22BDX61

KILO2400BDX /
SIERRA6BDX 5-30X56
SOK24BDX61

KILO1000BDX /
SIERRA3BDX 2.5-8X32
SOK10BDX01

KILO1000BDX /
SIERRA3BDX 3.5-10X42
SOK10BDX02

KILO1000BDX /
SIERRA3BDX 4.5-14X44
SOK10BDX03

KILO1600BDX /
SIERRA3BDX 2.5-8X32
SOK16BDX01

KILO1600BDX /
SIERRA3BDX 3.5-10X42
SOK16BDX02

KILO1600BDX /
SIERRA3BDX 4.5-14X44
SOK16BDX03

KILO1600BDX /
SIERRA3BDX 4.5-14X50
SOK16BDX04

KILO1600BDX /
SIERRA3BDX 6.5-20X52
SOK16BDX05

KILO1800BDX /
SIERRA3BDX 4.5-14X44
SOK18BDX01

KILO2200BDX /
SIERRA3BDX 4.5-14X50
SOK22BDX01

KILO2400BDX /
SIERRA3BDX 6.5-20X52
SOK24BDX01



SOK22BDX61



SOK10BDX02



SOK16BDX02



SOK22BDX01



THE CHOICE OF THE U.S. ARMY AND SPECIAL OPERATIONS

TANGO6T riflescopes have been selected by the U.S. Army and USSOCOM to deliver unmatched performance and optical clarity when it matters most. TANGO6T riflescopes are MIL-STD810G tested and approved and are assembled in the U.S.A.

30mm Maintube

SHARED FEATURES

- ▲ 6x super-zoom advanced optical system
- ▲ First and second focal plane reticles
- ▲ Throwlever included with all SKUs
- ▲ Fast focus eyepiece
- ▲ Waterproof (IPX-8 rated) and fog-proof performance
- ▲ Night vision illuminated reticle settings with locking dial
- ▲ Laser engraved mounting line to align riflescope to scope rings
- ▲ Flat dark earth anodized finish
- ▲ Assembled in the U.S.A.
- ▲ Designed for MSR/AR platforms

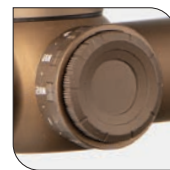

6X SUPER-ZOOM ADVANCED OPTICAL SYSTEM



FAST FOCUS EYEPIECE

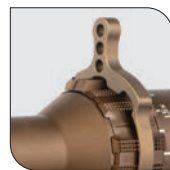

THROWLEVER INCLUDED WITH ALL SKUs

TANGO6T OPTIC HAS BEEN SELECTED BY:

The U.S. ARMY Squad Designated Marksman Rifle (SDMR)
 USSOCOM Squad-Variable Powered Scope (S-VPS)
 Department of Defense - Direct View Optic (DVO)

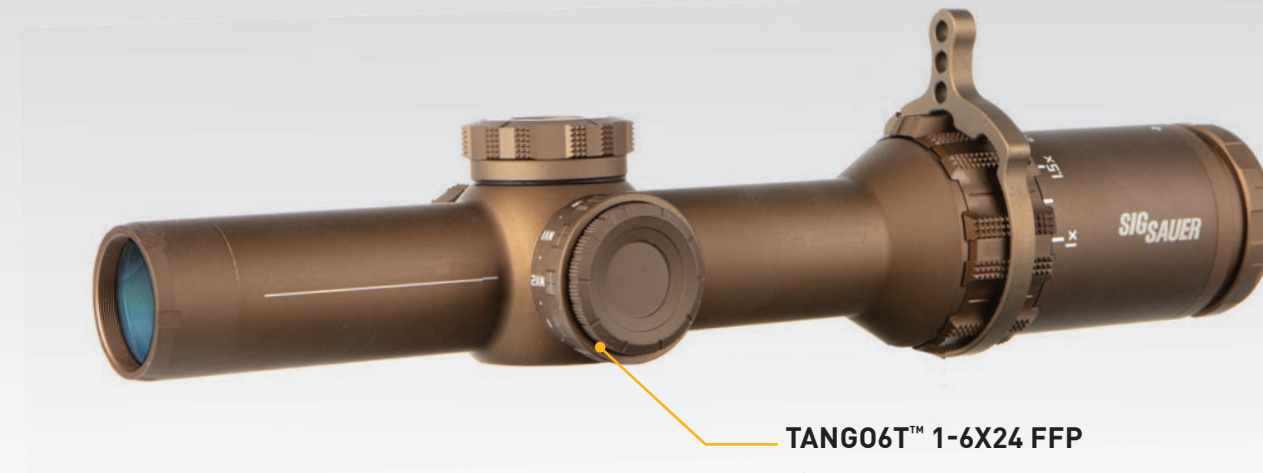

TANGO6T™ 1-6X24 FFP

30MM MAINTUBE
 SOT61231 / SOT23139

- ▲ Designed for MSR/AR platforms
- ▲ Ideal for close to mid-range tactical engagements.
- ▲ Fiber-optic power indicator
- ▲ Multiple reticle options available
- ▲ Daylight bright illumination with locking illumination dial



TANGO6T 1-6X24 SFP

30MM MAINTUBE
 SOT61230 / SOT61236

- ▲ Designed for MSR/AR platforms
- ▲ Ideal for close to mid-range tactical engagements.
- ▲ Fiber-optic power Indicator
- ▲ Multiple reticle options available
- ▲ HELLFIRE® Reticles: fiber-optics to vary intensity of central aiming point (SFP)
- ▲ Daylight bright illumination with locking illumination dial

1-6X24MM

FFP - 5.56/7.62 Horseshoe Dot
 FFP - DWLR6

SFP - MOA Milling HELLFIRE
 SFP - FL-6 HELLFIRE

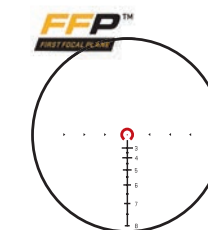

5.56MM / 7.62MM
 Horseshoe Dot



FL-6
 HELLFIRE



DWLR6

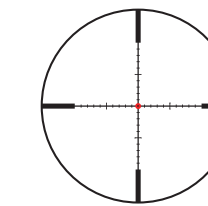

MOA MILLING
 HELLFIRE



PRECISION TACTICAL RIFLESCOPES

The TANGO6 6X super-zoom riflescope family has you covered for mid to long-range engagements, precision rifle competitions to big game hunting. From bolt actions to MSR's, the TANGO6 is built for versatility.

34mm Maintube

SHARED FEATURES

- ▲ 6X super-zoom advanced optical system
- ▲ Sunshade included
- ▲ Fast-focus eyepiece
- ▲ Waterproof (IPX-7 rated) and fog-proof performance
- ▲ T-120 tactical turret with 120 clicks per revolution
- ▲ LEVELPLEX® anti-cant system

FREE CUSTOM SBT®
WITH SELECT TANGO6™ PURCHASES



TANGO6™ 5-30X56 WITH LEVELPLEX®

34MM MAINTUBE
SOT65113 / SOT65114

- ▲ Long-range precision shooting, tactical engagements, and long-range hunting
- ▲ Fiber-optic power indicator
- ▲ Offered in FFP with multiple reticle options
- ▲ LEVELPLEX® anti-cant system

HDX®

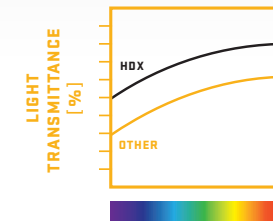

Advanced optical systems comprising both High Definition (HD) and High Transmittance (HT) glass for ultra-high resolution, optical performance, and light transmission.



FIBER OPTIC POWER INDICATOR



SIDE FOCUS ALLOWS USERS TO REMOVE PARALLAX



ADVANCED HDX® 6X OPTICAL SYSTEM



LEVELPLEX Digital Anti-Cant System utilizes an integrated digital level with user-selectable reticle cant detection at +/- 0.5° or +/-1° sensitivity.

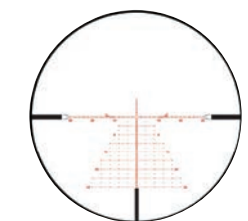

MOA DEV-L

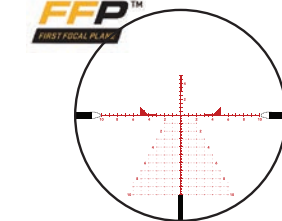

MRAD DEV-L

5-30X56MM

DEV-L MOA Milling, FFP
DEV-L MRAD Milling, FFP



LONG RANGE PRECISION RIFLESCOPES

With a 4X zoom first-focal plane design, illuminated glass reticles, and revolutionary resettable zero turret, TANGO4 riflescopes are the ideal solution for mid to long-range tactical engagements, designated marksmen, competitive shooters, and hunters.

30mm Maintube

SHARED FEATURES

- ▲ 4X super-zoom advanced optical system
- ▲ Lensarmor™: Abrasion-resistant lens coatings
- ▲ Built-in throw lever included
- ▲ Resettable zero turret
- ▲ Low Dispersion (LD) glass provides optical clarity for any situation
- ▲ Lensshield™: Proprietary Mil-Spec oleophobic coating for clean images
- ▲ Waterproof (IPX-7 rated) and fog-proof performance
- ▲ Stealth ID™: Deflection armor surfacing for less detection



TANGO4™ 6-24X50 RIFLESCOPE

30MM MAINTUBE
SOT46111 / SOT46112 / SOT46113 / SOT46114

- ▲ Designed for MSR/AR and bolt action platforms
- ▲ Long-range precision shooting, tactical engagements, and long-range hunting
- ▲ Fiber optic power indicator
- ▲ Offered in FFP with multiple reticle options
- ▲ LOCKDOWN® zero system



LENSARMOR™ Abrasion-resistant lens coatings for extreme durability ensures the lenses on your scope will stay sharp, bright, and clear.



STEALTH ID™: DEFLECTION ARMOR SURFACING FOR LESS DETECTION



RESETTABLE ZERO TURRET

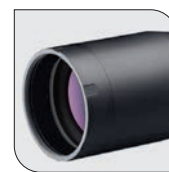

LOW DISPERSION (LD) GLASS PROVIDES OPTICAL CLARITY



TANGO4 4-16X44

30MM MAINTUBE
SOT44111

- ▲ Designed for MSR/AR and bolt action platforms
- ▲ Mid to long-range tactical engagements, designated marksman, and hunting
- ▲ Offered in FFP with multiple reticle options



TANGO4 1-4X24

30MM MAINTUBE
SOT41111

- ▲ Designed for MSR/AR and bolt action platforms
- ▲ Ideal for CQB / mid-range tactical engagements, 3-gun competitions and hunting
- ▲ Offered in FFP with multiple reticle options

RETICLES

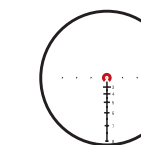

5.56mm / 7.62mm Horseshoe Dot

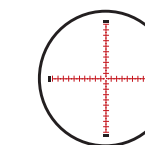

MOA/MRAD MILLING

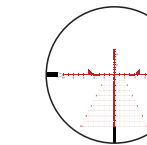

MOA/MRAD DEV-L

1-4X24 MM	5.56/7.62 Horseshoe Dot FFP
4-16X44 MM	MOA Milling, FFP
6-24X50 MM	DEV-L MOA Milling, FFP
	DEV-L MRAD Milling, FFP
	MOA Milling, FFP
	MRAD Milling, FFP



HUNTING RIFlescOPES

The WHISKEY3 riflescopes feature low dispersion glass, rugged chassis, and capped windage and elevation turrets. It's rugged industrial design provides reliability and protection from the elements.

1 inch Maintube

SHARED FEATURES

- ▲ 3X zoom optical system
- ▲ Stealth ID™: Deflection armor surfacing
- ▲ Lensarmor™: Abrasion-resistant lens coating
- ▲ HELLFIRE® Reticles: Fiber optics to vary intensity of central aiming point
- ▲ Low dispersion (LD) glass provides industry leading optical clarity
- ▲ European-style eyepiece for a smooth, fast, and precise reticle adjustment
- ▲ Waterproof (IPX-7 rated) and fog-proof performance
- ▲ 3X optical zoom, illuminated, and non-illuminated reticles
- ▲ Offered in second focal plane (SFP) and multiple reticles



WHISKEY3™ 3-9X40

1" MAINTUBE
SOW33202 / SOW33204 / SOW33206

- ▲ Designed for traditional / dangerous game hunting and MSR/AR platforms
- ▲ Extended long range scenarios, as well as low light shooting, and recreational shooting across a wide range of calibers
- ▲ Offered in SFP with multiple reticle options



HELLFIRE Reticle is an electronically illuminated reticle system utilizing advanced fiber-optic technology to vary the light intensity of the central aiming point from dim to HELLFIRE bright for daylight illumination.



STEALTH ID™: DEFLECTION ARMOR SURFACING | 3X ZOOM OPTICAL SYSTEM | LOW DISPERSION (LD) GLASS WITH LENSARMOR™

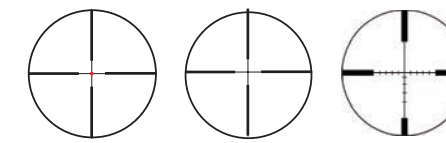

HELLFIRE® QUADPLEX® | QUADPLEX | BDC-1 QUADPLEX



WHISKEY3 4-12X50

1" MAINTUBE
SOW34201 / SOW34203 / SOW34205

- ▲ Designed for traditional / dangerous game hunting and MSR/AR platforms
- ▲ Medium and long-range engagements and recreational shooting across a wide range of calibers and light conditions
- ▲ Offered in SFP with multiple reticle options



WHISKEY3 4-12X40

1" MAINTUBE
SOW34202 / SOW34204 / SOW34206

- ▲ Designed for traditional / dangerous game hunting and MSR/AR platforms
- ▲ Medium and long-range engagements and recreational shooting across a wide range of calibers and light conditions
- ▲ Offered in SFP with multiple reticle options



WHISKEY3 3-9X50

1" MAINTUBE
SOW33201 / SOW33203 / SOW33205

- ▲ Designed for traditional / dangerous game hunting and MSR/AR platforms
- ▲ Short, medium and long-range engagements and recreational shooting across a wide range of calibers and light conditions
- ▲ Offered in SFP with multiple reticle options



WHISKEY3 2-7X32

1" MAINTUBE
SOW32201 / SOW32202

- ▲ Designed for traditional / dangerous game hunting and MSR/AR platforms
- ▲ Short, medium and long-range engagements and recreational shooting across a wide range of calibers and light conditions
- ▲ Offered in SFP with multiple reticle options



DIGITAL LASER RANGEFINDERS

The KILO family of Digital Laser Rangefinders is engineered for extreme accuracy. KILO products are the most advanced, and yet simple to use, rangefinders on the market today. Updating at 4X per second in HyperScan mode, all KILO rangefinders come with proprietary Lightwave DSP™ technology, are lightning fast, and amazingly accurate.

7X25 mm

FEATURES

- ▲ Revolutionary Lightwave DSP technology for the fastest and longest distance rangefinder engine
- ▲ SpectraCoat™ anti-reflection coatings for superior light transmission and optical clarity.
- ▲ HyperScan™ provides 4 range updates per second in scan mode while RangeLock reports the last range result when ranging distant targets
- ▲ Lumatic Display™ automatically calibrates display brightness to changing ambient light conditions
- ▲ Advanced rangefinder featuring an Embedded Applied Ballistics® elite calculator and Bluetooth® for synchronizing with a free Applied Ballistics app. Available on both IOS® and Android® platforms
- ▲ Integrated temperature, humidity, pressure, and compass



KILO2400ABS™ RANGEFINDER

7X25MM
SOK24701

- ▲ Ranges up to 2 miles
- ▲ Advanced rangefinder featuring an Embedded Applied Ballistics Elite™ calculator and Bluetooth® for synchronizing with a free Applied Ballistics app. Available on both IOS® and Android® platforms
- ▲ Integrated temperature, humidity, pressure, and compass
- ▲ New milling reticle with 2.4 MRAD inner diameter and 3 MRAD outer diameter center aiming circle. Milling features are 5 MRAD to the dots and 10 MRAD to the lines
- ▲ Includes a tripod adapter, smartphone jack windmeter, ballistic nylon molle kit bag, tactical pen/stylus, lanyard, and 3 spare batteries
- ▲ Assembled in U.S.A.

RANGES	Up to 1400 YDS DEER	Up to 1800 YDS TREES	Up to 3400 YDS REFLECTIVE
--------	---------------------	----------------------	---------------------------



EMBEDDED APPLIED BALLISTICS® ELITE CALCULATOR AND BLUETOOTH



SPECTRACOAT™ ANTI-REFLECTION COATINGS



INCLUDES TRIPOD ADAPTER, WINDMETER, PEN/STYLUS, MOLLE KIT BAG, & MORE.

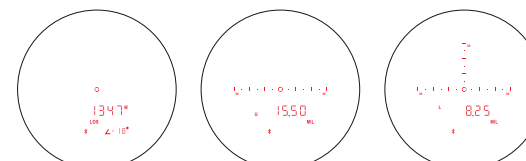

Configurable reticle with 3 options: Center Aiming Circle only, Center Aiming Circle and Horizontal Milling Grid, and Center Aiming Circle and Horizontal and Vertical Milling Grid



KILO1600™ RANGEFINDER

6X22MM
SOK16608

- ▲ Ranges up to 2000 yards with Lightwave DSP™ technology
- ▲ Features line of sight (LOS) or angle modified range (AMR™) units in yards meters to one-tenth Y/M resolution
- ▲ Transparent OLED display
- ▲ User-selectable target modes featuring LAST or BEST for pinpoint accuracy
- ▲ Simplified user interface with RANGE and MODE buttons only

RANGES	Up to 1000 YDS DEER	Up to 1200 YDS TREES	Up to 2000 YDS REFLECTIVE
--------	---------------------	----------------------	---------------------------



KILO1000™ RANGEFINDER

5X20MM
SOK10001

- ▲ Ranges up to 1200 yards with Lightwave DSP technology
- ▲ Features line of sight (LOS) or angle modified range (AMR™) units in yards meters to one-tenth Y/M resolution
- ▲ High transmittance LCD display
- ▲ User-selectable target modes featuring LAST or BEST for pinpoint accuracy
- ▲ Simplified user interface with RANGE and MODE buttons only

RANGES	Up to 800 YDS DEER	Up to 1000 YDS TREES	Up to 1200 YDS REFLECTIVE
--------	--------------------	----------------------	---------------------------



MICRO OPEN REFLEX SIGHT

The fastest, most accurate, ultra-compact micro reflex sight. The ROMEZero is optimized for everyday concealed carry, and for pistols with slim slides. The sight features a ruggedized, WeaponsGrade textured polymer body and the Spectracoat™ HD Polymer lens system.

The ROMEZero enables rapid target acquisition in an everyday carry package at an iron sight price.

1X24mm

FEATURES

- ▲ 8 vivid, user configurable daytime illumination levels
- ▲ MOTACT™ (Motion Activated Illumination System) that powers up when it senses motion and powers down when it does not
- ▲ Parallax free
- ▲ Highly efficient, point source LED emitter for a crisp dot that is 8 times more efficient than conventional red dots
- ▲ Integrated rear sight notch for co-witness with a standard height P365™ front sight
- ▲ Assembled in U.S.A.

ROMEZero IS COMPATIBLE WITH

- ▲ Direct mount to P365XL™
- ▲ Shield RMS-c footprint
- ▲ J Point™ footprint
- ▲ Delta Point® Pro footprint



SPECTRACOAT HD POLYMER LENS



WEAPONSGRADE ULTRALITE POLYMER HOUSING



ASSEMBLED IN U.S.A.

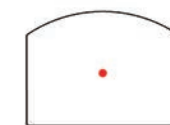

3 MOA

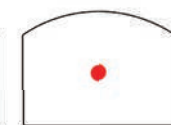

6 MOA



Now with steel protective shroud included for added durability



IDLE MOTION BEFORE RETICLE TURNS OFF

ROMEZero™

1X24MM
SOR01300 (3 MOA) / SOR01600 (6 MOA)

- ▲ Spectracoat HD polymer lens with 10 times the impact resistance over traditional glass lenses
- ▲ WeaponsGrade Ultralite polymer housing optimized for use with concealed carry pistols and slim slide profiles such as single-stack 1911s and subcompact firearms
- ▲ Stippling pattern on the housing matches P365™ and P365XL™ grip pattern, for an integrated look



Assembled in the U.S.A.



Designed for use on SIG SAUER® P365 pistols with optics ready slides

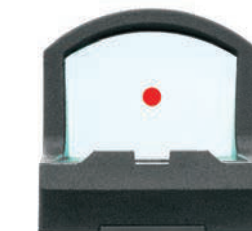

Rear View



MINIATURE OPEN REFLEX SIGHT

Designed for fast, responsive target acquisition, and accuracy. The miniature open-reflex ROME01PRO Red Dot sight was engineered to withstand the punishment of diverse environments.

1X30mm

SHARED FEATURES

- ▲ Molded glass aspheric lens for superior light transmittance and zero distortion
- ▲ Manual illumination controls that remember your last-used settings
- ▲ 3 or 6 MOA red dot with multiple brightness settings for rapid target engagement under a full range of lighting conditions
- ▲ MOTACT™ (Motion Activated Illumination) powers up when it senses motion and powers down when it does not
- ▲ Top-loading CR1632 battery, allowing for quick battery replacement without removal from the firearm
- ▲ Waterproof (IPX-7 rated for complete immersion up to 1 meter) and fog-proof performance
- ▲ Designed for modern semi-automatic pistols, MSR platforms and shotguns
- ▲ TruHold™ Lockless Zeroing System that utilizes twin adjustment springs designed to endure handgun recoil and return to zero shot after shot

ROME01PRO IS COMPATIBLE WITH

P320-M17, P320-M18, P320 XFIVE LEGION, P320 XCOMPACT, P320 XFULL, All PRO-CUT Slides, P320 Pro Series, and all RXP pistols and slides

*Please note, this product is not compatible with slides cut to accept a standard ROME01, such as GEN1 RX pistols



MOLDED GLASS ASPHERIC LENS

MANUAL ILLUMINATION CONTROLS

AIRCRAFT GRADE CNC ALUMINUM HOUSING



IDLE MOTION BEFORE RETICLE TURNS OFF

ROME01PRO™

1X30MM
SORIPI00 (3 MOA, BLK) / SORIPI01 (6 MOA, BLK) / SORIPI03 (6 MOA, FDE)

- ▲ Aircraft grade CNC aluminum housing ensures a lifetime of reliable service
- ▲ Ruggedized protective steel shroud included for extreme durability
- ▲ New emitter offers a brighter dot, more brightness settings (10 daylight and 2NV), and a longer battery life (20,000 hours)
- ▲ Designed to fit newer SIG SAUER® PRO-CUT slides

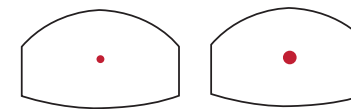

3 MOA RED DOT

6 MOA RED DOT



ROME01™

1x30MM
SORI1000 (3MOA) / SORI1600 (6MOA)

- ▲ ROME01 is compatible with legacy optics-ready SIG SAUER® pistols, such as the original P320RX, Classic Line RX, and P320 X-FIVE® pistols. It is not compatible with newer SIG SAUER optics-ready pistols that have the "PRO" slide cut. Those pistols accept the new ROME01PRO.



ROME01 Shroud Kit Also Available. (SOR1SK001)



Adapter Pack option available for Glock, CZ-75, Springfield XD, S&W M+P, S&W Core, HK P2000, 1911 standard, SIG SAUER 1911, P220*, P226*, P227, P229*, P239*, P225*, and P320. Please see sigsauer.com for additional options.

SORIMK001 / SORIMK002 / SORIMK003 / SORIMK004 / SORIMK005 / SORIMK006 / SORIMK007 / SORIMK008 / SORIMK009 / SORIMK010 / SORIMK011 / SORIMK012 / SORIMK013 / SORIMK014



MIL-SPEC RED DOT SIGHT

The ROME02 is built for use in adverse conditions. A 3 MOA or 6 MOA red dot with 15 brightness settings ensures rapid target engagement. The sight features a high-efficiency, point source LED emitter and molded aspheric glass lens, utilizing a high-performance red notch reflector coating for excellent brightness and light transmittance with zero distortion. The 7075 aluminum housing and ruggedized steel shrouds protect the ROME02 from extreme impacts and drops. The ROME02 maintains 25,000 hours of battery life, comes with MOTAC to automatically power the optic on and off, and is compatible with all SIG pistols that have the newer PRO-CUT slide.

1X30mm

FEATURES

- ▲ 25,000+ hour battery life at medium brightness settings with extreme brightness for outdoor use, plus multiple night vision levels
- ▲ Integrated anti-reflective rear sight notch for a full sight picture and co-witness with a front suppressor-height sight
- ▲ Spring-loaded side battery tray, released by a push button that can be activated without tools
- ▲ 2 steel shrouds included for 3 different optic configurations, including fully enclosed and sealed with a polycarbonate rear window
- ▲ MOTACT™ (Motion Activated Illumination System) that powers up when it senses motion and powers down when it does not
- ▲ MAGNETACT™ (Magnetic Activation) that automatically turns the optic off when holstered in a compatible holster, and instantly turns the optic on when drawn from the holster
- ▲ D.A.R.C. (Dark Adaptive Reticles & Coatings technology) provides ideal reticle brightness and target clarity while using night vision devices
- ▲ High-strength 7075 CNC aluminum housing ensures a lifetime of Service
- ▲ Dependable waterproof (IPX-7 rated for complete water submersion up to 1 meter) performance



MOLDED GLASS ASPHERIC LENS



3 OR 6 MOA DOT WITH 15 BRIGHTNESS SETTINGS (12 DAYLIGHT/3 NV)



HARDENED STEEL SHROUDS PROVIDE EXTREME DROP PROTECTION



Assembled in the U.S.A.



IDLE MOTION BEFORE RETICLE TURNS OFF

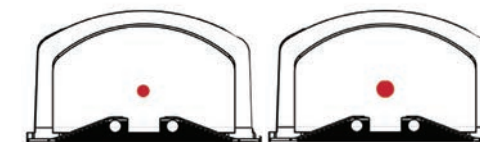

3 MOA RED DOT

6 MOA RED DOT

ROME02™

1X30MM
SOR21300 (3 MOA) / SOR21600 (6 MOA)

- ▲ Molded glass aspheric lens with high performance coatings for superior light transmittance and zero distortion
- ▲ 3 or 6 MOA dot with 15 brightness settings (12 daylight/3 NV) for rapid target engagement under a full range of lighting conditions
- ▲ TruHold™ Lockless Zeroing System that utilizes twin adjustment springs designed to endure handgun recoil and return to zero shot after shot



OPEN

HALF

FULL / SEALED

2 steel shrouds included for 3 different optic configurations, including fully enclosed and sealed with a polycarbonate rear window



The emitter area can be fully enclosed and sealed with a polycarbonate rear window, to ensure the reticle is never interrupted



Engineered to fit all SIG SAUER pistols with the R2 or PRO slide cut

ROME03™



COMPACT OPEN REFLEX SIGHTS

The open reflex ROME03, ROME03MAX and ROME03XL Red Dot sights are the ideal sighting solution for MSR rifles, shotguns, carbines, submachine guns, and full-size handguns; designed with competitive shooters in mind.

1X25mm 1X30mm 1X35mm

SHARED FEATURES

- ▲ High transmittance red notch reflector for excellent brightness and zero distortion
- ▲ MOTACT™ (Motion Activated Illumination) powers up when it senses motion and powers down when it does not
- ▲ Extremely strong and lightweight aircraft grade CNC aluminum housing ensures a lifetime of reliable service
- ▲ Side-loading CR2032 battery, allowing for quick battery replacement without removal from the firearm
- ▲ Waterproof (IPX-7 rated for complete immersion up to 1 meter) and fog-proof performance



2 MIN
IDLE MOTION BEFORE
RETICLE TURNS OFF

ROME03MAX™

1X30MM
SOR31003 (3 MOA), SOR32003 (6 MOA)

- ▲ Developed in collaboration with Team SIG Captain, 20-time National Champion Max Michel
- ▲ Compact, open reflex sight featuring a 30mm wide, round lens design for superior field-of-view
- ▲ 3 MOA or 6 MOA dot with 12 brightness settings for rapid target engagement under a full range of lighting conditions
- ▲ Comes with a low-profile M1913 picatinny mount. An absolute co-witness riser mount is also available as an accessory
- ▲ Red-notch filter for vivid red dot and unrivaled optical clarity

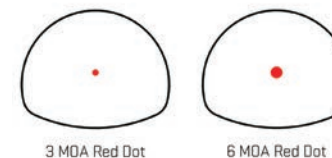

3 MOA Red Dot 6 MOA Red Dot



30MM WIDE, ROUND LENS DESIGN (MAX)
EXTREMELY STRONG AND LIGHTWEIGHT AIRCRAFT GRADE CNC ALUMINUM HOUSING
LOW PROFILE AND ABSOLUTE CO-WITNESS M1913 MOUNTS (ROME03)



ROME03XL™

1x35MM
SOR31004 (3 MOA) / SOR32004 (6 MOA)

- ▲ The ideal sighting solution for MSR rifles, shotguns, carbines, submachine guns, and full-size handguns
- ▲ Comes with a low-profile M1913 picatinny mount. An absolute co-witness riser mount is also available as an accessory
- ▲ Crisp 3 or 6 MOA red dot for fast and accurate shooting
- ▲ Up to 25,000 hours of runtime on a single CR2032 battery
- ▲ Massive 35mm wide lens for superior field of view and fast target transition



ROME03™

1x25MM
SOR31002

- ▲ Designed for MSR rifles, shotguns, carbines, submachine guns, and full-size handguns
- ▲ Proprietary red-notch coating ensures bright red dot
- ▲ Manual illumination controls
- ▲ Comes with low profile and absolute co-witness M1913 mounts



MIL-SPEC RED DOT SIGHT

With its wide field of view and forgiving eye-box, the battle hardened ROME08T is ideal for rapid target engagement in any environment..

1X38mm

SHARED FEATURES

- ▲ High performance coatings for excellent light transmittance and red dot contrast in all situations
- ▲ Unlimited eye relief to acquire aiming point and target, regardless of eye position behind sight
- ▲ MOTAC™ (Motion Activated Illumination Systems) powers up when it senses motion and powers down when it does not
- ▲ Ultra-dependable waterproof and fog-proof performance
- ▲ Quad Ballistic Circle Dot reticle with ballistic holds and 10 Daytime and NV Settings
- ▲ 1.53" optical center height for optical device compatibility
- ▲ 38mm rectangular viewing window for unmatched situational awareness and target identification
- ▲ .5MOA adjustments for zeroing, with ballistic drops built into the reticle for distance shooting without dialing
- ▲ CR123A battery provides 100,000 hours at high-brightness setting
- ▲ 1/2" hex bolt at 85 in/lb provides retention of zero during extreme conditions
- ▲ Assembled in the U.S.A.



HIGH-PERFORMANCE LENS COATINGS



REMOVABLE TITANIUM SHROUD



FLIP CAPS AND ANTI REFLECTIVE DEVICE INCLUDED



Available in FDE

ROME08T™ MIL-SPEC RED DOT SIGHT

1X38MM
SOR81002 (BLACK) / SOR81003 (FDE)

- ▲ Lightweight 7075 aluminum main housing and components
- ▲ Removable titanium shroud for ultimate optic protection from hard use
- ▲ Flip caps and anti-reflective device included
- ▲ Dependable IPX-8 waterproof: submersible to 20m for 30 minutes



Assembled in the U.S.A.



ROME08H™ RED DOT SIGHT

1X38MM
SOR81001 (BLACK)

- ▲ Aircraft grade 6061-T6 aluminum
- ▲ Dependable IPX-7 waterproof: submersible to 1m for 30 minutes

RETICLES

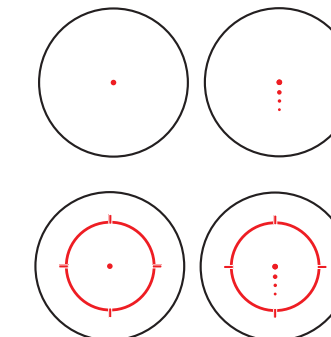

2 MOA Red Dot Ballistic Circle Dot



ROME04T OPTIC HAS BEEN SELECTED BY:

- The U.S. ARMY Special Operations
- Federal Bureau of Investigations (FBI)
- Department of Homeland Security, Customs and Border Protection (CBP)
- The U.S. Federal Government Bureau of Prisons

COMPACT RED DOT / GREEN DOT SIGHTS

Chosen by elite government and military agencies, the ROME04 is the ultimate Red Dot sight when fast, accurate target acquisition is a must, regardless of lighting conditions, weather conditions, or terrain. Whether it's a moving target, dangerous game at full charge, or a fast-breaking tactical situation at close quarters, the rugged ROME04 Red Dot sight can handle the job. Battery and solar powered options available.

1X20mm

SHARED FEATURES

- ▲ Unlimited eye-relief to acquire aiming point and target, regardless of eye position behind sight
- ▲ MOTACT™ (Motion Activated Illumination) powers up when sensing motion
- ▲ Utilizes an ultra efficient red LED illumination for daylight visibility and extended runtime
- ▲ Provides 12 illumination settings (10 daylight plus 2 NV) for visibility in all light conditions
- ▲ Strong and lightweight aircraft grade CNC aluminum housing (7075 grade on ROME04T)
- ▲ Absolute co-witness QR mount and low mount included (absolute co-witness 1/2" hex nut on ROME04T)
- ▲ Users can select from 4 different onboard reticle options, per model (dot, circledot, dot with holds, circledot with holds)
- ▲ Runtime in excess of 100,000 hours with solar and battery usage (ROME04T, ROME04DR, ROME04S)
- ▲ Comes standard with lens caps and mount
- ▲ Waterproof (IPX-8 rated) and fog-proof (ROME04T)
- ▲ Assembled in the U.S.A.



SELECT FROM 4 DIFFERENT ONBOARD RETICLE OPTIONS



TOP MOUNTED SOLAR PANEL



COMES STANDARD WITH LENS CAPS AND MOUNT



2 MIN
IDLE MOTION BEFORE
RETICLE TURNS OFF

Available
in Black

ROME04T™ MIL-SPEC RED DOT SIGHT

1X20MM
SOR43031 (BLACK) / SOR43032 (BLACK) / SOR43131 (FDE)

- ▲ Designed for AR platform pistols, MSR platforms, and shotguns
- ▲ Short and medium range engagements and recreational shooting across a wide range of calibers and light conditions
- ▲ MIL-SPEC 810G tested and approved
- ▲ Lightweight CNC 7075 aluminum housing ensures a lifetime of reliable service
- ▲ Runtime in excess of 100,000 hours with solar and CR2032 battery



Green Horse Shoe Ballistic Dot (ROME04H Only)

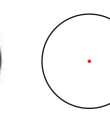
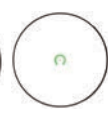

2 MOA Red Dot Ballistic Circle Dot

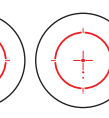
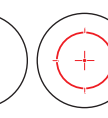
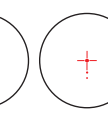
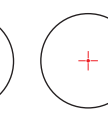
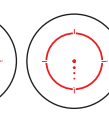
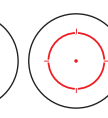

1 MOA Red Dot Ballistic Circle QUADPLEX®



ROME04DR™ COMPACT RED DOT SIGHT

1x20MM
SOR41111

- ▲ Short and medium range engagements and recreational shooting across a wide range of calibers and light conditions
- ▲ Selectable 2 MOA dot and 65 MOA circle dot reticles
- ▲ Comes standard with lens caps and mount



ROME04S™ COMPACT RED DOT SIGHT

1x20MM
SOR43021 / SOR43022

- ▲ Short and medium range engagements and recreational shooting across a wide range of calibers and light conditions
- ▲ Extended runtime with solar cell
- ▲ Comes standard with lens caps and quick-release mount



ROME04H™ COMPACT RED DOT SIGHT

1x20MM
SOR43011 / SOR43012 / SOR43013

- ▲ Comes standard with lens caps and quick-release mount
- ▲ 50,000+ hour battery life and the readily available CR2032 battery is side-loading for quick battery replacement



RED DOT SIGHT

The ROME07 line of red dot sights provide the civilian and armed professional with an intuitive 1x aiming solution optimized for today's MSR platforms, regardless of caliber.

1X30mm

FEATURES

- ▲ High performance lens coatings for excellent light transmission and dot contrast in any situation
- ▲ Easy-access rotary dial for complete control
- ▲ 2 MOA red dot is optimal for close quarters battle to mid-range engagement
- ▲ Side-loading for quick battery change
- ▲ Dependable IPX-7 waterproof and fogproof performance
- ▲ MOTAC™ powers up when it senses motion and powers down when it does not
- ▲ Compact size and weight with unlimited eye-relief and parallax free operation
- ▲ Aircraft grade aluminum housing and mount
- ▲ Includes slip over, see-through flip-backs



ROME07S™ COMPACT RED DOT SIGHT

1X22MM
SOR75001 / SOR75002

- ▲ Compact size and weight
- ▲ Powered by AAA battery for up to 50,000 hour run time
- ▲ Durable half-inch hex nut mount



SIDE-LOADING FOR QUICK BATTERY CHANGE



AIRCRAFT GRADE ALUMINUM HOUSING AND MOUNT



INCLUDES SLIP OVER, SEE-THROUGH FLIP-BACKS

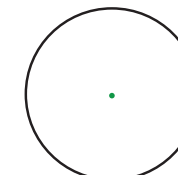

2 MOA Green Dot

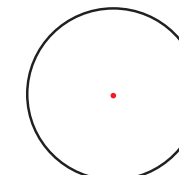

2 MOA Red Dot



ROME07™ FULL-SIZE RED DOT SIGHT

1X30MM
SOR71001

- ▲ Powered by AAA battery for up to 62,500 hour run time
- ▲ IPX-7 rated for complete immersion up to 1 meter

ROME05™



COMPACT RED DOT / GREEN DOT SIGHTS

The ROME05 Red Dot Sight mounts on any platform, and even though it's small, it's tough. The solid, lightweight aluminum design will give peak performance and years of service.

1X20mm

SHARED FEATURES

- ▲ Ultra-low parallax so point-of-aim is point-of-impact and the red dot remains parallel to the bore of your firearm, no matter what your viewing angle is relative to the optical axis of the sight
- ▲ Unlimited eye relief to acquire aiming point and target, regardless of eye position behind sight
- ▲ MOTAC™ (Motion Activated Illumination) powers up or down when sensing motion
- ▲ Ultra-dependable waterproof (IPX-7 rated for complete water immersion up to 1 meter) and fog-proof performance
- ▲ Runs on a single AAA battery for up to 50,000 hours of runtime under normal use
- ▲ Dual reticle (5XDR) quad reticle (Predator)



Available in FDE (5XDR only)

ROME05XDR™ COMPACT RED/GREEN DOT SIGHT

1X20MM
SOR52122 (PREDATOR) / SOR52102 (XDR) / SOR521XXX (FDE)

- ▲ 2 MOA red dot with 65 MOA circle provides 10 illumination settings (8 daylight plus 2 NV) for visibility in all light conditions
- ▲ Modular M1913 picatinny riser mount for 1.41" (absolute co-witness) or 1.63" (1/3 Lower co-witness) sight heights
- ▲ Dependable waterproof (IPX-7 rated for complete water immersion up to 1 meter) and fog-proof performance
- ▲ Green predator reticle model available with 4 green reticles (dot, dot with triangle, dot with lower triangle, and triangle only)



IDLE MOTION BEFORE
RETICLE TURNS OFF



HIGH-PERFORMANCE LENS COATINGS



RUNS ON A SINGLE AAA BATTERY



MODULAR M1913 PICATINNY RISER MOUNT

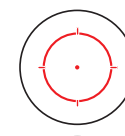

Circle-Dot (65 MOA Circle/ 2 MOA Dot)

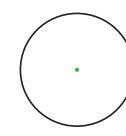

PREDATOR Dot



PREDATOR Dot with Triangle



PREDATOR Dot with Lower Triangle



PREDATOR Triangle Only



ROME05X™

1x20MM
SOR52101

- ▲ 2 MOA red dot provides 10 illumination settings (8 daylight plus 2 NV) for visibility in all light conditions
- ▲ Modular M1913 picatinny riser mount for 1.41" (absolute co-witness) or 1.63" (1/3 Lower co-witness) sight heights
- ▲ Dependable waterproof (IPX-7 rated for complete water immersion up to 1 meter) and fog-proof performance
- ▲ Runs on a single AAA battery for up-to 50,000 hours of runtime under normal use



ROME05 TREAD™

1x20MM
SOR52101

- ▲ 2 MOA red dot provides 10 illumination settings (8 daylight plus 2 NV) for visibility in all light conditions
- ▲ Integrated M1913 picatinny interface provides industry-standard mounting options for a wide range of applications
- ▲ Side-loading CR2032 battery allowing for quick battery replacement without having to remove the sight from the firearm
- ▲ TREAD logo laser engraved



ROME05

1x20MM
SOR52001

- ▲ 2 MOA red dot provides 10 illumination settings (8 daylight plus 2 NV) for visibility in all light conditions
- ▲ Integrated M1913 picatinny interface provides industry-standard mounting options for a wide range of applications
- ▲ Side-loading CR2032 battery allowing for quick battery replacement without having to remove the sight from the firearm

ROME0-MSR™



COMPACT RED DOT SIGHT

The ROME0-MSR is a sealed, compact red dot or green dot sight intended for MSR, carbine, shotgun, and air rifle. Brightness is adjusted with a top-mounted rotary dial, featuring 10 daytime and 2 night vision settings for quick target engagement in any condition.

1X20mm

FEATURES

- ▲ Ultra-compact size and weight with unlimited eye-relief and parallax-free operation
- ▲ Precise 2 MOA dot
- ▲ Slipover, see-through flip-backs
- ▲ Top-loading battery compartment with integral brightness control featuring 10 daytime and 2 NV settings
- ▲ Aircraft grade aluminum housing and mount
- ▲ Dependable IPX-7 waterproof and fog-proof performance



ROME0-MSR™

1X20MM
SOR72001 (RED) / SOR72002 (GREEN)

- ▲ 2 MOA high-performance lens coatings for excellent light transmission and dot contrast in any situation
- ▲ 1 MOA adjustments for zeroing
- ▲ 1.41" T10 Torx® M1913 skeletonized lightweight riser mount for absolute co-witness
- ▲ Over 20,000 hours runtime on a CR1632 battery

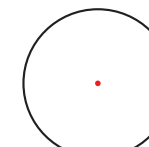

2 MOA Red Dot

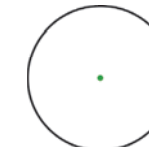

2 MOA Green Dot



HIGH-PERFORMANCE LENS COATINGS



TOP-MOUNTED ROTARY DIAL



SLIPOVER, SEE-THROUGH FLIP-BACK



Ultra-compact size and weight with unlimited eye-relief and parallax-free operation



MAGNIERS

Easily transition between close quarters and medium range targets with a flip of our JULIET magnifier. When used in conjunction with a Red Dot, the JULIET features a quick-release PowerCam mount which flips easily to one side when not in use. Built-in recoil lugs ensure zero-hold even after removing and reinstalling.

6x24mm

SHARED FEATURES

- ▲ Quick release mount with built-in recoil lugs for a repeatable zero
- ▲ PowerCam™ 90° mount pivots to the side when not needed
- ▲ Adjustable height using included spacers
- ▲ Aerospace grade 6061 aluminum housing ensures a lifetime of reliable service
- ▲ Waterproof rated IPX-8 (20 meters for 1 hour)
- ▲ Dialectic coated prism
- ▲ Compact size and weight
- ▲ Assembled in the U.S.A.



JULIET 6™ MAGNIER

6X24MM
SOJ61001

- ▲ Designed for MSR platforms and shotguns
- ▲ Power and versatility of a 1-6x scope, in a modular system
- ▲ Adjustable base mount provides customization for red dot sight combination



JULIET 3 MAGNIER

3x24MM
SOJ31001

- ▲ Designed for MSR platforms and shotguns
- ▲ Power and versatility of a 1-3x scope, in a modular system
- ▲ Adjustable base mount provides customization for red dot sight combination



JULIET 4 MAGNIER

4x24MM
SOJ41001 / SOJ41002

- ▲ Designed for MSR platforms and shotguns
- ▲ Power and versatility of a 1-4x scope, in a modular system
- ▲ Adjustable base mount provides customization for red dot sight combination

Available in
FDE



POWERCAM 90° MOUNT PIVOTS TO THE SIDE WHEN NOT NEEDED



QUICK RELEASE MOUNT WITH BUILT-IN RECOIL LUGS



AEROSPACE GRADE 6061 ALUMINUM HOUSING

ROMEO® AND JULIET COMBO KITS

JULIET 4™ AND ROMEO 4™ COMBO KIT (SORJ4311)
JULIET 3™ AND ROMEO 5™ COMBO KIT (SORJ5310)

ALL SPECIFICATIONS SUBJECT TO CHANGE



MICRO MAGNIFIERS / COMBO KIT

New for this year is the JULIET3-MICRO™ Magnifier. This ultra-compact and lightweight magnifier features an aircraft grade CNC aluminum housing and dependable IPX-7 waterproof and fog proof performance. With its high-performance Dielectric coated prism, the JULIET3-MICRO Magnifier provides excellent light transmission. Also new is the ROMEO-MSR™ Combo Kit, combining the ROMEO MSR compact red dot with the JULIET3-MICRO Magnifier.

The ROMEO MSR is a sealed compact red dot sight with 20,000+ hour battery life, high-performance lens coatings for excellent light transmission. The ROMEO MSR and JULIET3-MICRO have a 1.41 sight height for absolute co-witness.

3x22mm

SHARED FEATURES

- ▲ High performance lens coatings including dielectric-coated prism for excellent light transmission
- ▲ Ultra-compact size and weight
- ▲ Dependable IPX-7 waterproof and fogproof performance
- ▲ 90° push-button flip-to-side magnifier mount



ULTRA-COMPACT SIZE AND WEIGHT



AIRCRAFT GRADE CNC ALUMINUM HOUSING



HIGH PERFORMANCE LENS COATING



JULIET3-MICRO™ MAGNIFIER

3X22MM
SOJ3M001

- ▲ Ultra-compact size and weight
- ▲ Aircraft grade CNC aluminum housing ensures lifetime of reliable service
- ▲ Durable Half-inch hex nut mount
- ▲ Infinite Guarantee®



JULIET3-MICRO MAGNIFIER / ROMEO-MSR™ COMBO KIT

3x22MM / 1x20MM
SORJ72001

- ▲ Ultra-compact size and weight
- ▲ Aircraft grade CNC aluminum housing ensures lifetime of reliable service
- ▲ Precise 2 MOA dot
- ▲ Lens covers included
- ▲ 1.41 Sight height for absolute co-witness
- ▲ Top-loading, rotary illumination brightness control featuring 10 daytime and 2 NV settings





THERMAL REFLEX SIGHT

The most innovative, direct view thermal sight in the world. The ECHO3 uses SIG SAUER® BDX® technology and can record both video and images in 8 different color palettes.

1-6x23mm 2-12x40mm

FEATURES

- ▲ Compact thermal reflex style sight (don't get stuck "behind" a scope)
- ▲ BDX enabled WiFi/Bluetooth®, allowing active reticles that change with KILO® rangefinder input, and customizable fixed reticles that are configured from the BDX mobile application
- ▲ Uncooled 320x240 12um VOx LWIR core operating at 30Hz
- ▲ LEVELPLEX® Anti-Cant System with scope cant sensitivity down to 0.5°
- ▲ MOTACT™ (Motion Activated Display) powers up when it senses motion
- ▲ Video and image recording (including recoil activation) with 8 color palettes
- ▲ Greater than 6 hours of run time with heavy use
- ▲ Easy to adjust lens with optional throw lever attachment
- ▲ Quick disconnect mount
- ▲ Designed and assembled in the U.S.A. to withstand IPX-4 conditions

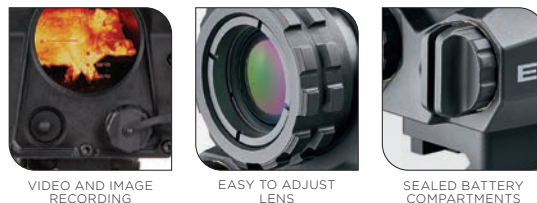

VIDEO AND IMAGE RECORDING

EASY TO ADJUST LENS

SEALED BATTERY COMPARTMENTS



Active Reticle

Custom Holdover Reticle

ECHO3™

1-6X23MM / 2-12X40MM
SOEC31001 / SOEC32001

- ▲ Aspheric lens (10° FOV) with up to 6X digital magnification
- ▲ Designed for predator and hog hunters
- ▲ Improved situational awareness
- ▲ Quick disconnect mount



Ballistic Data Xchange

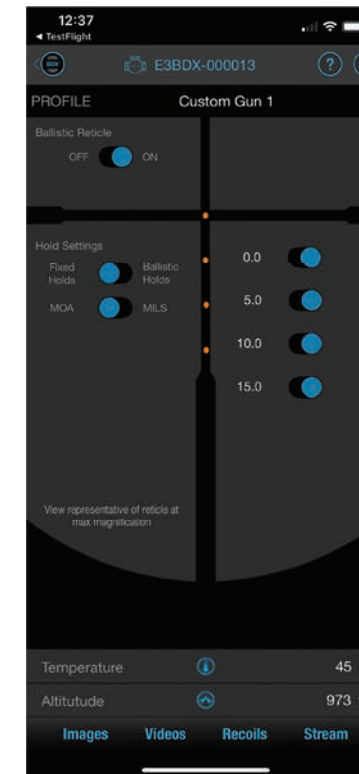

BDX Application

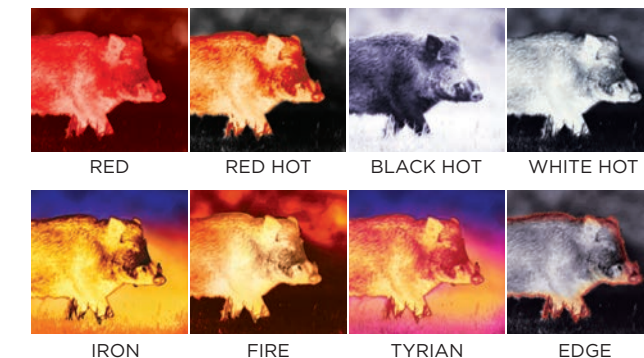

RED

RED HOT

BLACK HOT

WHITE HOT

IRON

FIRE

TYRIAN

EDGE



BATTLESIGHTS

The BRAVO battlesights combine crystal-clear fixed-power optics, intuitive reticles, super-bright illumination, and a rugged aluminum housing into one attractive package. Featuring 5.56/.308 and .300 Blackout reticles, this family will enhance any MSR/AR platform.

3x24mm

SHARED FEATURES

- ▲ Easily adjust illumination with side-mounted rotary dial featuring 8-daytime and 3 NV settings
- ▲ MOTACT™ (Motion Activated Illumination) powers up when it senses motion and powers down when it does not
- ▲ Lensarmor™: Abrasion-resistant lens coatings to withstand the harshest of conditions
- ▲ MEGAVIEW advanced prism and ocular design yields 40% greater field of view than the competitive prism-based battle sights
- ▲ Low dispersion (LD) glass provides industry leading optical clarity
- ▲ Adjustable eyepiece with +/- 2 diopter correction
- ▲ Integrated picatinny rails for accessories
- ▲ IPX-7 rated for complete immersion of up to 1 meter



IDLE MOTION BEFORE RETICLE TURNS OFF

BRAVO3™ BATTLESIGHT

3X24MM
SOB33101 / SOB33102

- ▲ Designed for professionals and civilian MSR/AR shooters
- ▲ 40% wider field of view than current battlesights
- ▲ Distortion-free Image, edge-to-edge clarity



MEGAVIEW ADVANCED PRISM AND OCULAR DESIGN



ADJUSTABLE EYEPIECE WITH +/- 2 DIOPTRER CORRECTION



INTEGRATED PICATINNY RAILS FOR ACCESSORIES

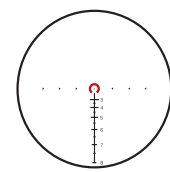

5.56MM / 7.62MM Horseshoe Dot

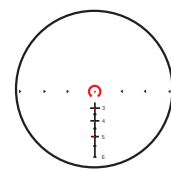

300 Blackout Horseshoe Dot



BRAVO5™ BATTLESIGHT

5X30MM
SOB53101 / SOB53102

- ▲ Designed for traditional / dangerous game hunting and MSR/AR platforms
- ▲ Short, medium, and long range engagements and recreational shooting across a wide range of calibers and light conditions

MEGAVIEW™

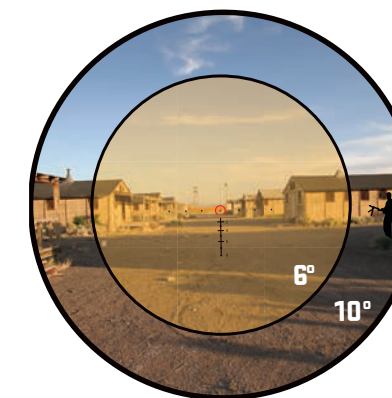

Massive 10° Field of View, 40% Wider Than Standard 6° Sights. That's 53 Feet of View at 100 Yards vs. 37 Feet



BRAVO4™ BATTLE PACK

Introducing the BRAVO4 Battle Pack; The ultimate tactical solution. This Battle Pack combines a 4x32mm Prismatic Battle Sight with a shroud-equipped 1x24mm ROME0Zero™ reflex sight. Featuring MEGAVIEW™, the BRAVO4 provides a forty percent increase in field of view and eye relief with distortion free image and edge to edge clarity. Extended range hits are made fast with the illuminated 5.56/7.62 ballistic reticle. The top mounted ROME0Zero Reflex Sight features a ruggedized, WeaponsGrade™ textured polymer body and the SpectraCoat™ HD Polymer lens allowing quick transition to CQB when needed.

3x24mm

FEATURES

- ▲ MOTAC™ (Motion Activated Illumination) powers up when it senses motion and powers down when it does not
- ▲ SpectraCoat™ HD polymer lens with 10 times the impact resistance over traditional glass lenses (ROME0Zero)
- ▲ MEGAVIEW advanced prism and ocular design yields 40% greater field of view than the competitive prism-based battle sights (BRAVO4)
- ▲ Low dispersion (LD) glass provides industry leading optical clarity (BRAVO4)
- ▲ Adjustable eyepiece with +/- 2 diopter correction
- ▲ Integrated picatinny rails for accessories
- ▲ IPX-8 rated for complete immersion of up to 1 meter (BRAVO4)
- ▲ IPX-67 rated for complete immersion of up to 1 meter (ROME0Zero)



SPECTRACOAT™ HD POLYMER LENS (ROME0ZERO)



LOW DISPERSION (LD) GLASS (BRAVO4)



WINDAGE AND ELEVATION ADJUSTMENTS

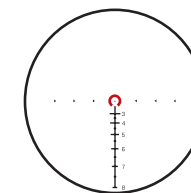

5.56MM / 7.62MM Horseshoe Dot

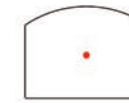

3 MOA Dot



BRAVO4™ BATTLE PACK 1X / 4X

4X32MM / 1X24MM
SOB44005

- ▲ Side-loading AA for quick battery change
- ▲ Distortion-free image with edge to edge clarity
- ▲ Ballistic reticle for 5.56 / 7.62 calibers
- ▲ Locking diopter adjustment
- ▲ Shroud-equipped ROME0Zero™



2 MIN
IDLE MOTION BEFORE
RETICLE TURNS OFF



Assembled in the U.S.A.



Side-loading AA for quick battery change. Shroud-Equipped ROME0Zero included

MEGAVIEW™

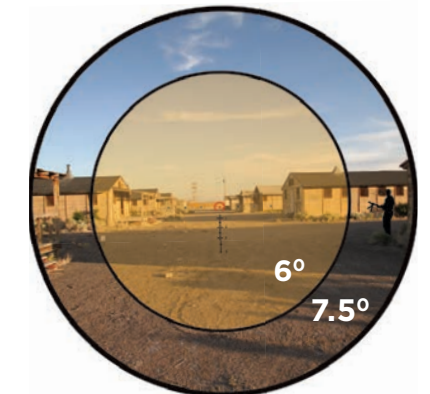

Massive 7.5° field of view, 40% wider than standard 6° sights. That's 53 feet of view at 100 yards vs. 37 feet



BINOCULARS

Next to a zeroed rifle, a clear and bright pair of binoculars is the best piece of gear to have on hand. ZULU binoculars perform in the harshest conditions, giving unmatched performance in inclement weather or rugged terrain.

- 16X42mm
- 10X30mm
- 10X42mm
- 11X45mm
- 15X56mm

FEATURES

- ▲ Combines superior optical performance with in-the-field utility
- ▲ High-quality glass, fully multi-coated Spectracoat™ lenses
- ▲ Phase-coated prisms provide maximum brightness, contrast, and crisp resolution
- ▲ Performs in the harshest conditions, giving unmatched performance in inclement weather or rugged terrain
- ▲ Superior low-light performance



FULLY MULTI-COATED SPECTRACOAT™ LENSES



DURABLE RUBBER ARMOR NON-SLIP GRIP DESIGN



MULTI-POSITION TWIST-UP EYECUPS

ZULU6™ IMAGE STABILIZED BINOCULAR

16X42
SOZ61601

- ▲ Optical image stabilization, prism is electronically stabilized by a 2 axis gimbal
- ▲ Compensates for human motion input into optics allowing for handheld use of high magnification optics, eliminates shake due to buffeting winds, heavy breathing after a long hike, cold-induced shivering, washboard ranch roads, chop on water, etc.
- ▲ MOTAC™ conserves battery life by turning unit off after 5 minutes of no motion



ZULU6™ IMAGE STABILIZED BINOCULAR

10X30MM
SOZ61001



ZULU9™ HDX® ABBE-KOENIG PRISM

11x45 / 15x56
SOZ99002 / SOZ99003

- ▲ Combines superior optical performance with in-the-field utility
- ▲ High-quality glass, fully multi-coated Spectracoat™ lenses
- ▲ Phase-coated Abbe-Koenig prisms provide maximum brightness, contrast and crisp resolution



ZULU7™ HDX OPEN-BRIDGE

10X42MM
SOZ71001

- ▲ Multi-position twist-up eyecups provide a custom fit for each user
- ▲ Fully multi-coated roof prism binocular incorporates super high reflectance phase-coated BAK4 prisms for unmatched resolution and image contrast
- ▲ Field & Stream Best of the Best Winner 2016



ZULU5™ HD OPEN-BRIDGE

10X42MM
SOZ52101

- ▲ HD glass for superior clarity and color correctness
- ▲ Silver deposition phase-coated BAK4 prisms
- ▲ Lightweight and durable magnesium alloy body



SPOTTING SCOPES

The OSCAR family of spotting scopes delivers unmatched image clarity and performance when it matters most. The OSCAR3 mini-spotting scope puts a powerful optic in the palm of your hand, and features the advanced Optical Image Stabilization (OIS) technology, for improved image quality at the highest magnification, to make spotting your target faster and easier. Ideal for backpacking, hunting, wildlife and sports observation, along with law enforcement and military reconnaissance. The new OSCAR8 angled eyepiece spotting scope is the newest addition to the OSCAR family of spotting scopes from SIG SAUER®. Featuring the industry-leading HDX® optical design, extra-low dispersion glass with high light transmittance glass, and full multi-coated lenses to deliver unmatched resolution, image contrast, and color clarity. When spotting in the field for long periods, the ergonomic design and durable rubber armor of the OSCAR8 delivers unmatched results in all conditions.



27-55X80mm

FEATURES

- ▲ HDX advanced optical system comprising both high Definition (ED) and high transmittance (HT) glass for ultra-high resolution, optical performance, and light transmission
- ▲ SCHMIDT-PECHAN prism, combined with HD glass, provide unmatched chromatic and spherical aberration correction for clear, vibrant images
- ▲ Spectracoat™ highly efficient, ultra-wide broadband, anti-reflection lens coatings reduce surface reflections to extremely low levels across the entire visible spectrum providing superior light transmission
- ▲ Angled eyepiece, combined with rotating tripod collar, provides the user with multiple viewing angles, to accommodate setup and usage in any terrain
- ▲ Comes equipped with a variable power eyepiece. This eyepiece can be locked into place or removed so that the OSCAR8 can accept other variable or fixed power eyepieces.



SPECTRACOAT™ ANTI-REFLECTION LENS COATINGS



ANGLED EYEPIECE AND ROTATING TRIPOD COLLAR



VARIABLE POWER EYEPIECE

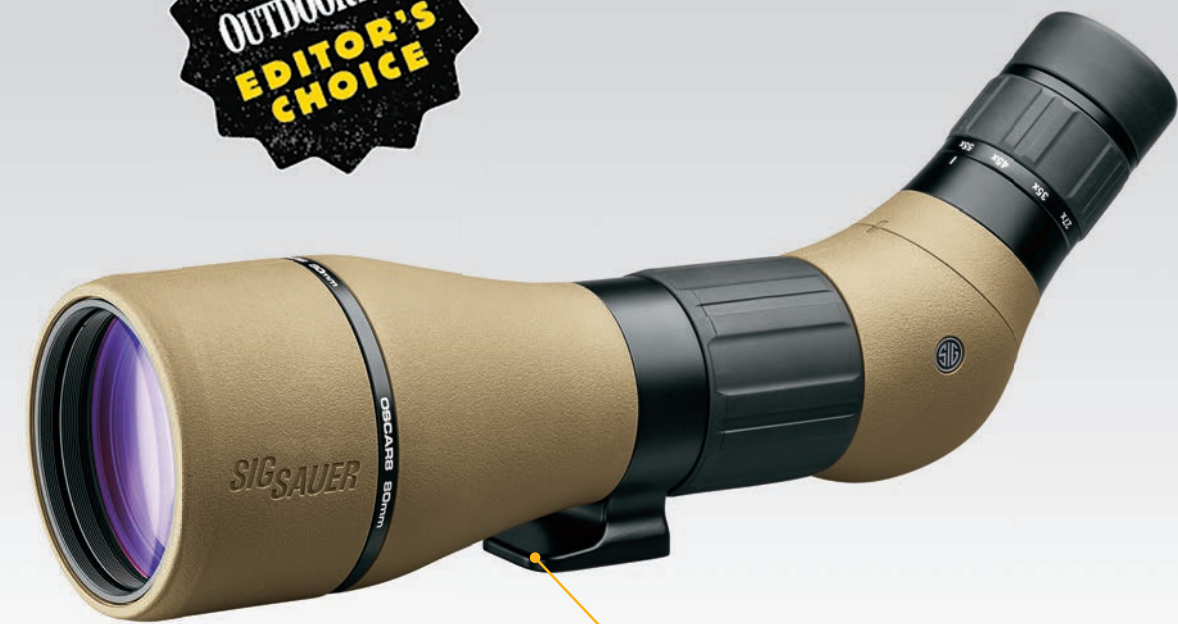

OSCAR8™

27-55X80MM
SO082001

- ▲ Waterproof and fog proof, the OSCAR8 will provide unmatched performance in all environmental conditions
- ▲ Adjustable eyecups allow the user to optimize eye relief for use with or without glasses
- ▲ Lightweight and robust aircraft grade aluminum housing, combined with rubberized non-slip grip armor, ensures a lifetime of use in the worst conditions
- ▲ Custom SIG SAUER® fitted neoprene cover included
- ▲ Assembled in U.S.A.

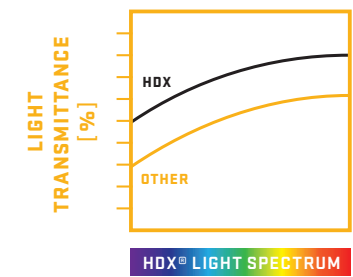

Advanced optical systems comprising both High Definition (ED) and High Transmittance (HT) glass for ultra-high resolution, optical performance and light transmission.



OSCAR3™

10-20X30MM
SOV31001

- ▲ Advanced electronic image stabilization technology that fits in the palm of a hand
- ▲ OIS Optical image stabilization removes human motion and jitter for improved image quality and target identification under high magnification
- ▲ Ideal for backpacking, hunting, wildlife and sports observation, law enforcement, and military reconnaissance
- ▲ The small size and capability of the OSCAR3 is ideal for backpacking, spot/stalk and tree stand archery, or long range rifle hunting in open country or mountains as well as concealed viewing situations for LE or military use



STABILIZED

UNSTABILIZED

LIMA[®]

LASER SIGHTS

The most advanced red or green lasers on the market, the proprietary LIMA laser grip module and low-profile LIMA laser integrate seamlessly with your SIG SAUER[®] pistol.

STANDARD FEATURES

- ▲ Latest generation 5 MW red or green lasers for unmatched runtime
- ▲ Ambidextrous laser activation supports all grip types
- ▲ Windage and elevation adjustments
- ▲ Powered by lithium 1/3N battery
- ▲ Instant activation tact switch
- ▲ Assembled in U.S.A.



LIMA365™
PISTOL LASER
SOL36501 (RED) / SOL36502 (GREEN)

- ▲ Ideal for target shooting, conceal carry, and personal defense
- ▲ Designed to perfectly fuse against the SIG P365[®] trigger guard for seamless fit
- ▲ Powered by lithium 1/3N battery
- ▲ Instant-activation tactile switch
- ▲ Shown with P365[®] pistol, (not included)



Assembled in the U.S.A.



LIMA320™
LASER GRIP
SOL51001 (RED) / SOL51002 (GREEN)

- ▲ Integrates and fits perfectly with our P320[®] and P250[®] pistol platforms
- ▲ State-of-the-art laser targeting in a package that is stealth and virtually invisible to the operator
- ▲ Same material as SIG SAUER standard polymer frames and textured to match
- ▲ Seamlessly integrates either a Red (osram) or direct green (osram) high-quality and high-efficiency laser module for extreme accuracy
- ▲ Works with carry, compact and full size
- ▲ Shown with P320 slide, magazine, and trigger group, (not included)



Assembled in the U.S.A.



LIMA1™
WEAPON MOUNTED LASER
SOL11001 (RED) / SOL11002 (GREEN)

- ▲ Ideal for target shooting, conceal carry, and personal defense
- ▲ Designed to fit M1913 and SIG rails
- ▲ Powered by lithium 1/3N battery
- ▲ Instant-activation left and right tactile switches
- ▲ Shown with M17[®] pistol, (not included)

FOXTROT[®]

WEAPON MOUNTED LIGHTS

The FOXTROT series of pistol lights provide bright, crisp, white light and come ready to mount on your SIG SAUER[®] pistol.



FOXTROT2™
WEAPON MOUNTED LIGHT
SOF21000

- ▲ 550 lumens and 1.5 hours of runtime
- ▲ Powered by 1 CR123 battery, loaded via a removable bezel with lockout mode
- ▲ M1913/SIG and Glock sliding rail interface plates included for maximum location adjustment range on the rail
- ▲ Ambidextrous rocking paddle switches, which are interchangeable with multiple sizes included
- ▲ Programmable user interface with 3 different modes including momentary, latching, and threshold, for mission specific customization



Assembled in the U.S.A.



FOXTROT1X™
WEAPON MOUNTED LIGHT
SOF12001

- ▲ 450 lumens and 1.5 hours of runtime
- ▲ Powered by 1 CR123 battery, loaded via a removable bezel with lockout mode
- ▲ M1913/SIG and Glock[®] sliding rail interface plates included for maximum location adjustment range on the rail
- ▲ Ambidextrous push-button side switches, with momentary and latching modes



FOXTROT1™
WEAPON MOUNTED LIGHT
SOF11001

- ▲ Mounts to any picatinny 1913 or SIG SAUER[®] proprietary rails
- ▲ Dual, finger-actuated tactile switches support ambidextrous use
- ▲ User-selectable output from 100 / 200 / 300 lumens
- ▲ Momentary or continuous-on with 5 minute auto-timeout
- ▲ Dependable waterproof (IPX-7 rated for complete water immersion up to 1 meter) and fog-proof performance



FOXTROT 365™
WEAPON MOUNTED LIGHT
SOF36501

- ▲ Up to 100 lumens and 3 hour run time
- ▲ Ideal for law enforcement, concealed carry, and personal defense
- ▲ Designed to perfectly fuse with the SIG P365[®] trigger guard for a seamless fit
- ▲ Latest generation Cree LEDs for maximum brightness and runtime
- ▲ Instant-activation tactile switch
- ▲ Powered by lithium 1/3N batteries
- ▲ Shown with P365 pistol (not included)
- ▲ Assembled in U.S.A.



Assembled in the U.S.A.

X-RAY3™

ENHANCED DAY/NIGHT SIGHTS

The X-RAY® family of pistol sights make target acquisition intuitive and fast in any lighting condition. The high contrast front sights paired with the glare reducing rear sights keep your focus on the front sight. The X-RAY3 line uses a 3-dot tritium system for the most demanding low light environments

FEATURES

- ▲ Oversized chemical-resistant fluorescent polymer front dot sight gives confidence in any environment
- ▲ Torture tested to 20,000 rounds, the steel housing provides a tough, reliable sight that lasts as long as the firearm
- ▲ Rear sights come in standard SIG SAUER® sizes of #6 and #8
- ▲ Fits SIG SAUER P238®, P938®, P250®, P320® and classic line models

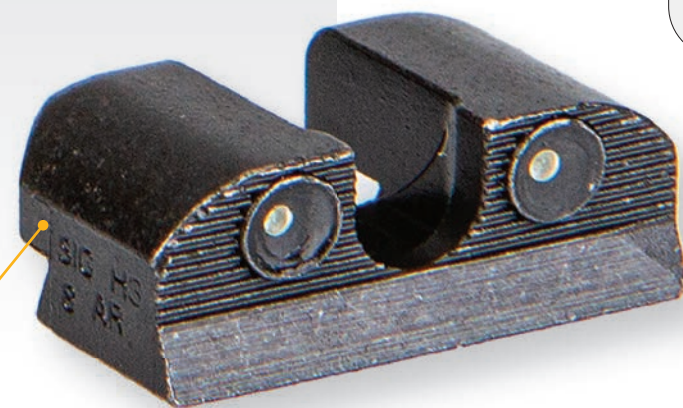
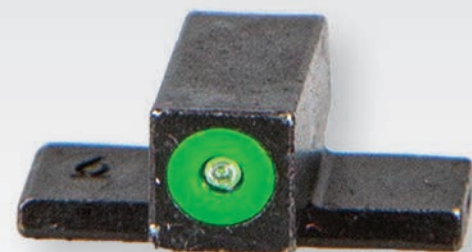

STANDARD HEIGHT XRAY3 SIGHTS



SUPPRESSOR HEIGHT SIGHTS

X-RAY3™ ENHANCED DAY/NIGHT SIGHTS

PISTOL SIGHTS
SOX10001 (SQUARE) / SOX10002 (ROUND U) / SOX10003 (SQUARE) / SOX10004 (ROUND U)

SOX10005 (SQUARE) / SOX10006 (ROUND U) / SOX10007 (SQUARE) / SOX10008 (ROUND U) / SOX10009 (SUPPRESSOR HEIGHT)

- ▲ With a half-life of 12 years, the 3-Dot tritium system allows for fast target acquisition in low-light conditions
- ▲ Oversized chemical resistant fluorescent polymer front dot provides confidence in all environments
- ▲ X-RAY3 come in SIG SAUER sizes of #6 and #8, Square or Round (U) notched rear sight

ADDITIONAL AVAILABLE SKUS

SOX10010: XRAY3 SIGHT SET, DAY/NIGHT, GLOCK®, STANDARD
SOX10011: XRAY3 SIGHT SET, DAY/NIGHT, GLOCK, TALL
SOX10012: XRAY3 SIGHT SET, DAY/NIGHT, GLOCK 42/43, STANDARD

ALPHA™

RIFLESCOPE MOUNTS/RINGS

Our hard-black-anodized, precision-machined, ALPHA Tactical Rings are crafted from aircraft-grade aluminum. Built with the same unique industrial design as our electro-optics, our rings and mounts not only look tough, they are tough. Our proprietary steel-alloy ALPHA Hunting Rings are machined with an exactness that is both strong and ductile, which allows our rings to form around a riflescope, and will not cause damage with proper installation. The steel rings are epoxy powder coated to prevent oxidation and resist gun oils, cleaning solutions, and outdoor exposure.



ALPHA3™ SCOPE MOUNT

WEAPON MOUNTED LIGHT
SOA30001 | 30MM 0 CANT
SOA30003 | 30MM 0 MOA
SOA30005 | 34MM 0 CANT
SOA30006 | 30MM 20 MOA CANT
SOA30007 | 34MM 20 MOA CANT

- ▲ Lightweight cantilever design optimized for use on MSR platforms
- ▲ Precision-machined to exacting standards from 7075 aluminum
- ▲ Titanium hardware for superior performance
- ▲ Available heights ranging from 1.375" - 1.535"
- ▲ Available weights ranging from 4.6oz - 4.7oz
- ▲ Assembled in U.S.A.



ALPHA2™ TACTICAL

SCOPE MOUNT
SOA20001 | 30MM 0 CANT (BLACK)
SOA20002 | 30MM 20 MOA CANT (BLACK)
SOA20003 | 34MM 0 CANT (BLACK)
SOA20004 | 34MM 20 MOA CANT (BLACK)
SOA20005 | 30MM 20 MOA CANT (FDE)

Available in FDE

- ▲ Cantilever design for use on MSR platforms
- ▲ 0 or 20 MOA cant options
- ▲ 1.53" high
- ▲ Available weights ranging from 5.2oz - 5.5oz



ALPHA2 RED DOT MOUNT

UNIVERSAL RED DOT MOUNT
SOA20011 | 30MM 12 O'CLOCK POSITION
SOA20012 | 30MM 45° OFFSET
SOA20013 | 34MM 45° OFFSET

- ▲ Universal mounting interface compatible with most popular red dot sights
- ▲ Positions red dot sight above scope tube
- ▲ Compatible with 30 or 34mm riflescopes



ALPHA1™

SCOPE RINGS
SOA10011 / SOA10012 / SOA10013 / SOA10014 / SOA10015 / SOA10016
SOA10017 / SOA10018 / SOA10019 / SOA10020 / SOA10021 / SOA10022
(MACHINED ALUMINUM)
SOA10003 / SOA10004 / SOA10005 / SOA10006 / SOA10007 / SOA10008 (MACHINED STEEL)
SOA10001 / SOA10002 (HUNTING)

- ▲ Proprietary weaver-style rings that are epoxy powder-coated to prevent oxidation and resist gun oils, cleaning solutions, and outdoor exposure, set of 2
- ▲ Available heights ranging From 0.75" - 1.25"
- ▲ Available weights ranging from 1.3oz - 6.7oz

SUPPRESSORS



PISTOL SUPPRESSOR



WELCOME TO THE FUTURE OF SILENCE.

SIG SAUER engineers have developed the next generation of pistol suppressors. With decades of product design and R&D experience under our belts, suppressors are not treated as bolt-on accessories. At SIG SAUER, it is understood that suppressors interact with your firearm's system and can affect accuracy, reliability, back-pressure, and other critical factors. We design our suppressors to be part of a completely integrated system to maximize overall performance, and as a result we build the most advanced, most dependable suppressors the world has ever seen, or heard.

The pistol suppressor line from SIG SAUER features completely modular and configurable titanium baffles for the ultimate in lightweight performance that allows the user to personalize their suppressor for overall length, weight, and sound. The MODX-9™ and MODX-45™ provide class-leading sound performance and can be easily disassembled and reconfigured with fewer baffles when your priority is size over sound. The MODX™ suppressors feature 21 points of impact adjustment and come with a fixed-barrel spacer for carbine use. Each MODX suppressor includes the most popular inch and metric piston for its given caliber.

9mm 45AUTO

SHARED FEATURES

- ▲ Segmented titanium 3D-printed
- ▲ Titanium baffles
- ▲ Shooter can adjust the number of baffles to shape the overall length when size is more important than sound performance
- ▲ Includes two pistons (1/2"x28tpi & M13.5x1LH) and fixed-barrel spacer (MODX-9)
- ▲ .578X28 and M16X1LH (MODX-45)
- ▲ Multi-Caliber capable with accessory pistons (MODX-45)



MODX-9™
9mm
MODX-9



MODX-45™
45AUTO
MODX-45

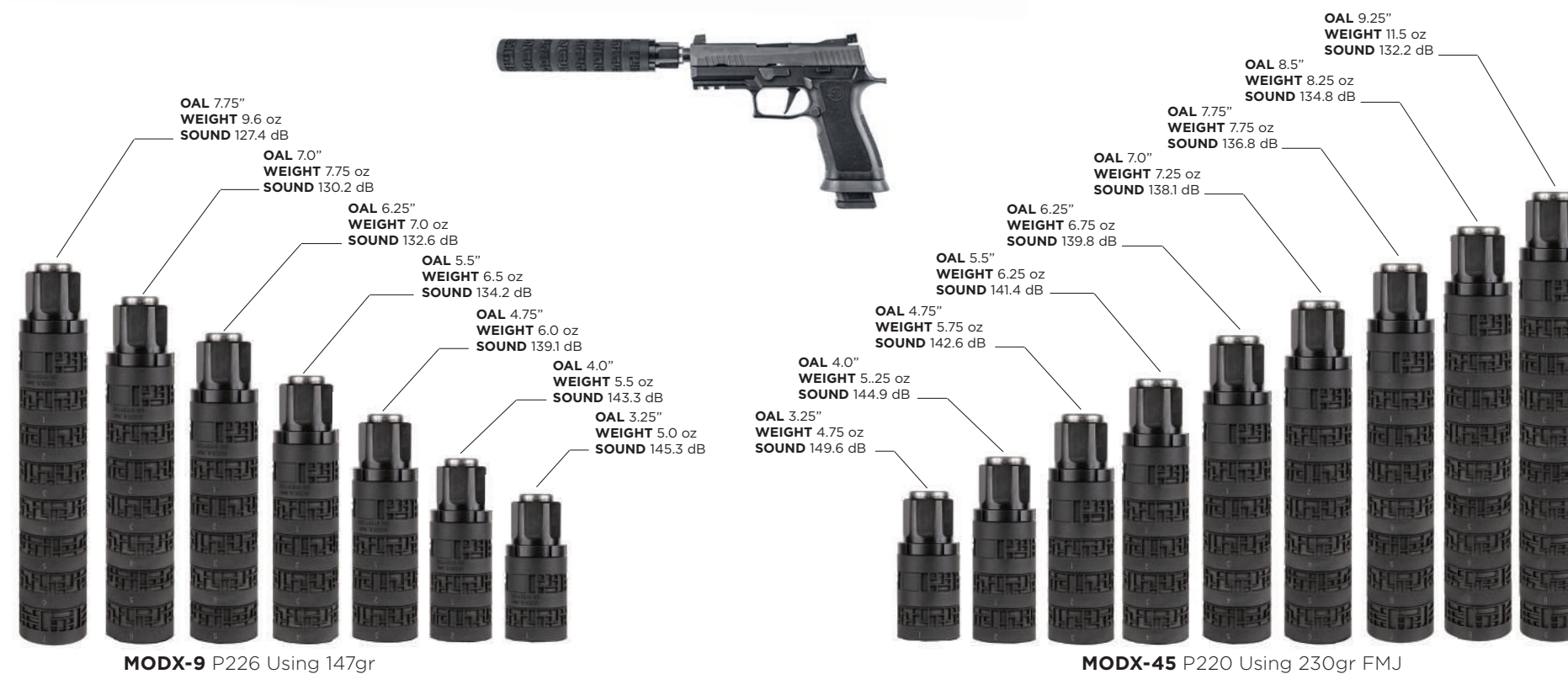

All dB measurements taken in a controlled environment with sound levels measured at (1M left of muzzle, Shooter left ear, Shooter right ear). Actual results may vary with shooting environment, weapons platform, and ammunition selection.

RIFLE SUPPRESSOR



SLX™ RIFLE SUPPRESSORS

The next generation of suppressor technology has arrived. The SLX series of rifle suppressors from SIG SAUER were born out of today's modern military requirements and are designed to deliver cutting-edge performance. The new Clutch-LOK™ QD mounting system is easy to use, repeatable, and extremely durable. The cross-flow baffle design delivers an entirely new shooting experience, focusing on the reduction of harmful toxic gases to the user which allows gases to expand and cool at a faster rate than a traditional design, while minimizing an increase in bolt speed.

The SLX series is ideal for users that have a focus on reduction of flash, toxic gas, and cyclic rate increases.

5.56NATO

SHARED FEATURES

- ▲ Caliber imprinted on device
- ▲ Muzzle device included 1/2"x28tpi (QD suppressors)

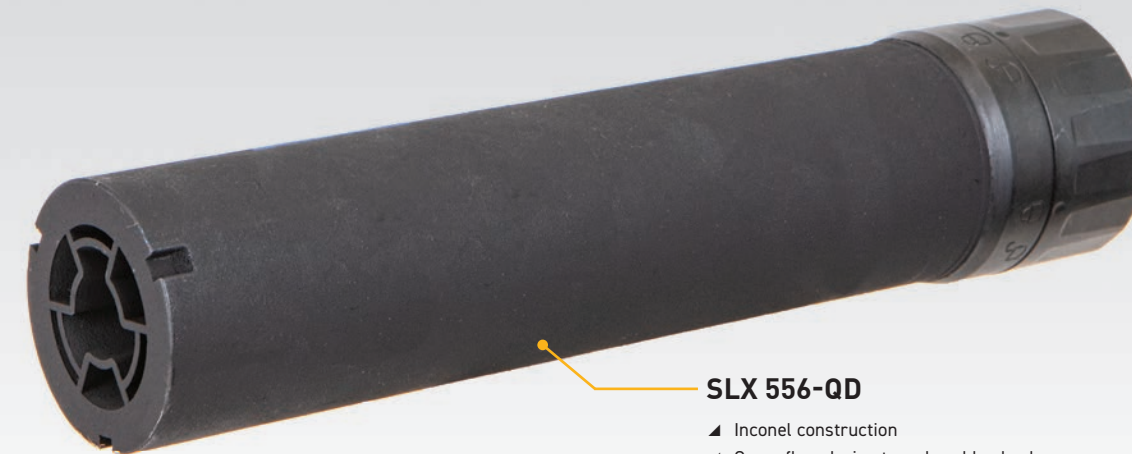

SLX 556-QD

- ▲ Inconel construction
- ▲ Cross flow design to reduce blowback
- ▲ Clutch-LOK™ QD mounting system or direct thread-on



SLX 556 DIRECT THREAD



SLX 556-QD



SLXC 556 DIRECT THREAD



SLXC 556-QD



SLX END DESIGN



CLUTCH-LOK QD MOUNTING SYSTEM



CALIBER IMPRINTED ON OUTER CASE

SLX™	Caliber	Length (in)	Width (in)	Weight w/Mag (oz)	Material
SLX 556	5.56 NATO	7.4 in / 188 mm	1.67 in / 42 mm	1.09 lbs / 17.4 oz	Inconel and Stainless Steel
SLX 556-QD	5.56 NATO	7.4 in / 188 mm	1.67 in / 42 mm	1.2 lbs / 19.2 oz	Inconel and Stainless Steel
SLXC 556	5.56 NATO	5.2 in / 132 mm	1.67 in / 42 mm	0.79 lbs / 12.6 oz	Inconel and Stainless Steel
SLXC 556-QD	5.56 NATO	5.2 in / 132 mm	1.67 in / 42 mm	0.91 lbs / 14.6 oz	Inconel and Stainless Steel

RIFLE SUPPRESSOR



SLH™ RIFLE SUPPRESSORS

The next generation of suppressor technology has arrived. The SLH series of rifle suppressors from SIG SAUER were born out of today's modern military requirements and are designed to deliver cutting-edge performance. The new Clutch-LOK™ QD mounting system is easy to use, repeatable, and extremely durable. The cross-flow, hybrid-baffle design delivers an entirely new shooting experience, focusing on a combination of best in class sound reduction and less harmful toxic gases than traditional suppressor designs.

The SLH series of rifle suppressor gives many of the benefits of the SLX series, with a primary focus on sound signature. The SLH series is ideal for low pressure rounds or when sound signature reduction is the number one priority.

300BLK 7.62NATO

SHARED FEATURES

- ▲ Caliber imprinted on device
- ▲ Titanium construction (SLH300TI, SLH300TI-QD, SLH762TI, SLH762TI-QD, SLH762TIC, 762TIC-QD)
- ▲ Muzzle device included 5/8"x24tpi (QD suppressors)



SLH END DESIGN



CLUTCH-LOK QD MOUNTING SYSTEM



CALIBER IMPRINTED ON OUTER CASE



SLH 762-QD

- ▲ Inconel and stainless steel construction
- ▲ Cross-flow design to reduce blowback
- ▲ Clutch-LOK™ QD mounting system or direct thread-on



SLH 762TI-QD



SLH 762TI



SLHC 762TI-QD



SLHC 762TI



SLH 300TI-QD

SLH	Caliber	Length (in)	Width (in)	Weight w/Mag (oz)	Material
SLH 300TI	300 BLK	8.93 in / 227 mm	1.67 in / 42 mm	0.88 lbs / 14.1 oz	Titanium
SLH 300TI-QD	300 BLK	8.93 in / 227 mm	1.67 in / 42 mm	1.0 lbs / 16 oz	Titanium
SLH 762TI	7.62 NATO	7.5 in / 191 mm	1.67 in / 42 mm	0.75 lbs / 12 oz	Titanium
SLH 762TI-QD	7.62 NATO	7.5 in / 191 mm	1.67 in / 42 mm	Titanium	Titanium
SLHC 762TI	7.62 NATO	5.3 in / 135 mm	1.67 in / 42 mm	0.55 lbs / 8.8 oz	Titanium
SLHC 762TI-QD	7.62 NATO	5.3 in / 135 mm	1.67 in / 42 mm	0.67 lbs / 10.7 oz	Titanium

RIMFIRE SUPPRESSOR



MORE ROUNDS. LESS NOISE

SIG engineers are using cutting-edge innovation to establish a new standard in accuracy and durability for .22LR suppressors.

The SRD22X 22LR can be used on both pistols and rifles and features a Grade 9 Titanium outer tube with 17-4 stainless steel baffles. Due to the durability of its materials, the SRD22X can be used with .22LR pistols and rifles chambered in .17HMR/.17 Mach II and .22 Magnum. The SRD22X ships with a 1/2x 28tpi mount, with an additional M9.75 mount available for purchase in the near future, and is fully user-serviceable.

.22LR

FEATURES

- ▲ Wrench included
- ▲ Used on both pistols and rifles



SRD22 END DESIGN FITS WRENCH



SMOOTH OUTER CASING



ALL 17-4 STAINLESS BAFFLES

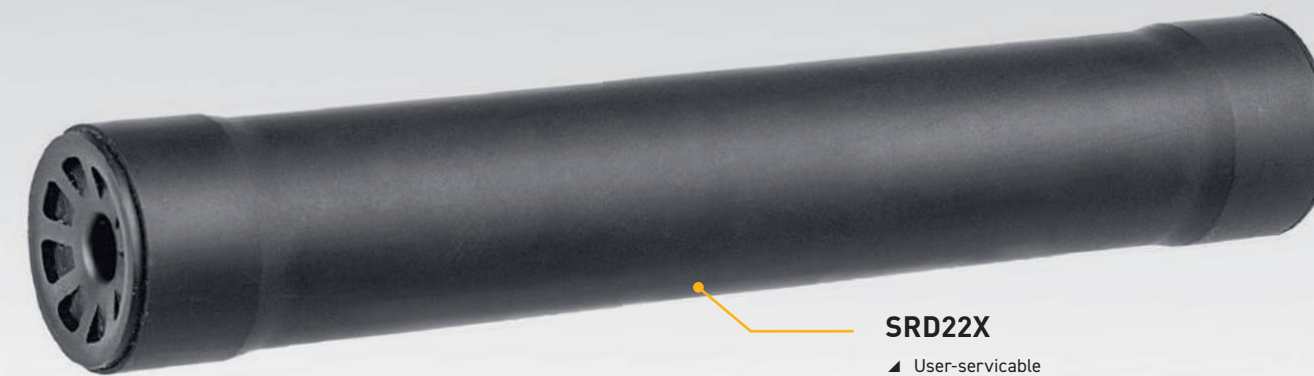

SRD22X

- ▲ User-serviceable
- ▲ Grade 9 titanium tube
- ▲ All 17-4 stainless baffles
- ▲ Rated from 22 LR to 22 MAG



USER-SERVICEABLE

RIMFIRE

	Caliber	Length (in)	Diameter (in)	Weight w/Mag (oz)	Material
SRD22X	22 LR to 22 MAG	5.8 in / 147 mm	1.0 in / 25.4 mm	5.1 oz	Titanium and Stainless Steel

SIG AIR®





SIG AIR BY SIG SAUER®

From the most elite name in firearms comes the most innovative line of airguns and airsoft guns which combines the unmatched reliability, performance, and exacting standards of SIG SAUER.

The SIG AIR product line includes a series of traditional CO² pellet and BB rifles and pistols designed to imitate the look, weight, balance, and handling characteristics of their traditional firearms counterparts. SIG AIR has also developed a precision line of break barrel, pre-charged pneumatic (PCP), and single-stroke pneumatic rifles and pistols, all meeting the high standards of SIG SAUER firearms.

SIG AIR has expanded to training products with the PROFORCE® line of airsoft pistols, rifles, and accessories. Designed and developed from the ground up to deliver a realistic training experience, that allows the user access to achieve a new level of unrealized performance potential. The SIG AIR PROFORCE series of pistols and rifles allows for flexibility in your training environment and is an economical alternative to training with firearms.

Consistency was the focus when developing the SIG AIR PROFORCE line. Each PROFORCE model closely matches its real steel complement in model specifications and delivers an authentic user experience. The PROFORCE line is also engineered to SIG quality standards using authentic materials and, where necessary, patented performance innovations.

Perfected for muscle memory exercises, shooting drills, and tactical training, these airsoft and airgun models are the economic and authentic answer to training more often, more effectively, and more affordably.

The full line of SIG AIR products delivers a completely authentic SIG handling experience, with the firepower you can rely on, for all of your hunting, sporting, and practical training needs.

Shoots like a SIG, because it is one.



SIG AIR **DESIGNED TO MATCH THE ORIGINALS**

- 1 | **All Metal or Polymer Construction**
Some models a combination of both
- 2 | **Front and Rear Flip-up Sights**
On some rifle models
- 3 | **Red Dot or Scopes**
Included on some models
- 4 | **Realistic Controls**
Controls match our rifles and pistols
- 5 | **Removable or Adjustable Stock**
On some models
- 6 | **Picatinny Rail**
Mount your favorite accessories
- 7 | **Safety Orange Tip**
On PROFORCE models
- 8 | **Realistic Trigger**
Smooth action similar to originals
- 9 | **Reload Mags Just Like Originals**
Drop magazines using similar releases
- 10 | **Full Blowback Slide**
Slide cycles back and forth
- 11 | **Weight Similar to Original**
Great as a training tool

PROFORCE[®] MCX



AUTOMATIC ELECTRIC GUN (AEG)

Modeled after its real steel counterpart, the PROFORCE release of the SIG SAUER MCX Virtus™ Airsoft AEG (Automatic Electric Gun) Rifle does not disappoint. With a full CNC machined receiver, integrated M-LOK® handguard, 3-position telescoping stock, open full-length Picatinny rail for the addition of sights, and a modular locking accessory mounting system, the MCX Virtus is a polymer airsoft BB slinging brute with 120 round mid-cap magazine that keeps you active and engaged on the firing line.

6mm AIRSOFT BB

FEATURES

- ▲ 120rd BB magazine
- ▲ Quick change tuning springs (110mm & 120mm included)
- ▲ 11.1v LiPo battery (not included)
- ▲ Sight ready platform
- ▲ Orange safety tip
- ▲ Attach your favorite accessories
- ▲ Familiar AR controls
- ▲ Velocity up to 375 FPS*

MCX VIRTUS™



3-POSITION TELESCOPING STOCK



120 ROUND BB MAGAZINE



ALL METAL RECEIVER AND M-LOK HANDGUARD CONSTRUCTION FOR ACCURATE WEIGHT AND HANDLING



PROFORCE VIRTUS MCX

- ▲ All metal CNC machined receiver and handguard
- ▲ M-LOK® handguard and Picatinny rail
- ▲ Safe, semi, and full auto firing modes
- ▲ 3-position telescoping stock

*Please Note

- ▲ Velocity obtained with 0.20g BBs
- ▲ For best results use 11.1V LIPO battery and appropriate charger.
- ▲ 11.1V LIPO battery is the maximum battery compatible with this rifle.
- ▲ Batteries and chargers sold separately. Please visit your local or online AirSoft retailer for accessories, batteries and chargers.

MCX	SKU	Caliber	Action Type	Operating System	Stock Type	Forend Type	Weight w/Mag (oz)	Overall Length (in)	Collapsed Length (in)	Barrel Length (in)	Construction	Velocity (FPS)	Mag Type	Mag Capacity
VIRTUS AEG	AIR-PF-MCXAEG	6MM BB	Semi-Auto	Auto Electric Gun	3-Position Telescoping	M-LOK	7.0	29.0	N/A	11.5	Metal	Up to 375	AR-15	120



AIRSOFT PISTOLS

For the first time the SIG SAUER Modular Handgun System (MHS) is available in an airsoft platform for the training professional. The SIG AIR® PROFORCE M17™ and M18™ have the same look, feel, and action as the official sidearms selected by all branches of the U.S. Military.

6mm AIRSOFT BB

SHARED FEATURES

- ▲ Full blowback metal slide
- ▲ Field strippable with similar balance and weight as firearm counterpart
- ▲ Picatinny rail mount

M17 / M18



OPTIC READY SLIDE WITH REMOVABLE REAR SIGHT PLATE



CO2 OR GREEN GAS COMPATIBLE



FIELD STRIPPABLE WITH SIMILAR BALANCE AND WEIGHT AS THE REAL M17



GREEN GAS Only

PROFORCE M18

- ▲ Optic-ready slide (AIR-REFLEXSIGHT)
- ▲ Compatible with CO² and green gas magazine
- ▲ Based on the M18 firearm selected by the U.S. Military
- ▲ Velocity up to up to 320 fps* green gas / 410 fps* CO²



GREEN GAS Version Available

PROFORCE M17

- ▲ Optic-ready slide (AIR-REFLEXSIGHT)
- ▲ Compatible with CO² and green gas magazine
- ▲ Based on the M17, the official handgun of all branches of the U.S. Military
- ▲ Velocity up to Up to 320 fps* green gas / 410 fps* CO²



SIG AIR REFLEX SIGHT

PRO FORCE	SKU	Caliber	Mag Capacity	Length (in)	Height (in)	Width (in)	Barrel Length (in)	Weight w/Mag (oz)	Sights	Grip Type	Construction	Slide Finish	Velocity up to (FPS)
M18	AIR-PF-M18GG	6mm BB	21	7.5	6.5	1.5	4.0	2.0	White Dot / Mount Plate	Polymer	Metal / Poly	Nitron	320 / 410
M17	AIR-PF-M17 / AIR-PF-M17-GG	6mm BB	21	8.5	6.5	1.5	5.0	2.25	White Dot / Mount Plate	Polymer	Metal / Poly	Nitron	320 / 410
P229	AIR-PF-229	6mm BB	23	7.5	5.2	1.25	4.5	2.5	White Dot	Polymer	Metal / Poly	Nitron	295

MCX VIRTUS PCP



SEMI-AUTOMATIC PRE-CHARGED PNEUMATIC RIFLE

The MCX VIRTUS PCP rifle is the latest expansion to the SIG AIR® precision line of airguns, and the introduction of SIG AIR products to the pre-charged pneumatic (PCP) category of airguns. The MCX VIRTUS PCP doubles the muzzle energy of classic CO2 models and uses the SIG Rapid Pellet Magazine, making it ideal for target training and varmint hunting.

.22CAL PELLETS

FEATURES

- ▲ 17.5" barrel
- ▲ 12FP muzzle energy
- ▲ Flip-up front and rear sights
- ▲ Picatinny top rail for mounting optics
- ▲ Clip-on stock with sling attachment points
- ▲ M-LOK® rail for mounting accessories
- ▲ Familiar AR controls

*Please Note

- ▲ Pellets are sold separately.
- ▲ Results may vary based on ammo weight, temperature, and altitude.

MCX VIRTUS™



3,000 PSI, 13 CU. IN. REMOVABLE TANK



FLIP-UP FRONT AND REAR SIGHTS



12FP MUZZLE ENERGY



MCX VIRTUS™

- ▲ 3,000 psi, 13 cu. in. removable tank
- ▲ 1,100 psi regulated output
- ▲ 30rd RPM™ Rapid Pellet Magazine
- ▲ Velocity up to 700 fps*



SIG RPM™ RAPID PELLET MAGAZINE

The unparalleled performance of the SIG SAUER patented pellet drive system smoothly feeds up to 30 rounds in 3.5 seconds. Rifle comes standard with one magazine and refillable belt. Accessory RPM (purchased separately) includes three spare belts.

*Velocity achieved with 13.7g Pellets



SIG AIR ACCESSORIES
Page 180-181



MCX	SKU	Caliber	Action Type	Operating System	Stock Type	Forend Type	Weight w/ Mag (oz)	Overall Length (in)	Collapsed Length (in)	Barrel Length (in)	Construction	Velocity up to (FPS)	Mag Type	Mag Capacity
VIRTUS	AIR-VIRTUS-22	.22 cal	Semi-Auto	Pre-Charged Pneumatic	Fixed	M-LOK	7.5	37.25	N/A	16.0	Metal / Poly	700	AR-15	30



BREAK BARREL AIR RIFLES

Introducing the most advanced break barrel system in the marketplace, engineered and produced by SIG SAUER® in New Hampshire. The common misconception among many is, "high muzzle velocity that makes for a better air rifle". In actuality, foot-pound muzzle energy is a more accurate gauge of the power of air rifles than the speed at which a projectile comes out of the barrel. Down-range accuracy and retained energy are better with a heavier projectile leaving the barrel at subsonic speed rather than an impractically lightweight projectile leaving the barrel at a supersonic speed of 1400+ feet per second. This .177CAL suppressed single-shot, Advanced Sport Pellet (ASP) air rifle delivers down-range power and accuracy, with the lightest cocking effort in its class, making it ideal for hunting small to medium game.

.177CAL PELLETT **.22CAL PELLETT**

SHARED FEATURES

- ▲ Smooth and consistent 2-Stage MATCHLITE™ trigger
- ▲ GLIDELITE® cocking mechanism ensures lightest cocking effort in this power level
- ▲ Proprietary drill-pinned breech wedge lock system for enhanced accuracy
- ▲ Single shot pellet rifle
- ▲ Built in U.S.A.



2-STAGE MATCHLITE TRIGGER



GLIDELITE COCKING MECHANISM



PROPRIETARY DRILL-PINNED BREECH WEDGE LOCK SYSTEM



ASP20™ SYNTHETIC STOCK

- ▲ Synthetic stock with QD mounts for sling usage
- ▲ Energy: 20 FP in .177 cal / 23 FP in .22 cal
- ▲ Velocity up to 1020 fps* in .177 cal/ 840 fps** in .22 cal



SIG AIR DAGGER / ZERO Lead Pellets Page 181

ASP20	SKU	Caliber	Action Type	Operating System	Stock Type	Weight w/mag (oz)	Overall Length (in)	Overall Height (in)	Barrel Length (in)	Construction	Velocity up to (FPS)	Mag Capacity	Sights / Optics
SYNTHETIC	AIR-ASP20-1721 / AIR-ASP20-2221 AIR-ASP20-1721ISC / AIR-ASP20-2221ISC (SCOPE OPTIONS)	.177 / .22 cal	Single Shot	Break Barrel	Synthetic	7.5	45.5	6.0	18.0	Steel / Syn	1020 / 840	1	Whiskey ASP Scope (Some Models)
WOOD	AIR-ASP20-1711 / AIR-ASP20-2211 AIR-ASP20-1711ISC / AIR-ASP20-2211ISC (SCOPE OPTIONS)	.177 / .22 cal	Single Shot	Break Barrel	Wood	7.5	45.5	6.0	18.0	Steel and Wood	1020 / 840	1	Whiskey ASP Scope (Some Models)

*Velocity achieved with 8.64gr lead pellet
**Velocity achieved with 14.65gr lead pellet

AIR MCX™ RIFLE



SEMI-AUTOMATIC CO₂ AIR POWERED

Based on the original designs of the SIG SAUER® MCX™, this CO₂ version is ideal for training and practice.

Just like the SIG SAUER MCX redefined the modern compact rifle, the SIG AIR® line of MCX rifles redefines the CO₂ category of air rifles by delivering authentic SIG performance, handling, and rapid-fire capability.

.177CAL PELLETT

SHARED FEATURES

- ▲ Metal housing with polymer handguard and stock
- ▲ 30rd RPM pellet magazine
- ▲ Picatinny rail
- ▲ Vertical foregrip
- ▲ 90g CO₂ power source (sold separately)
- ▲ 18" rifled barrel
- ▲ Velocity up to 700 fps*



90g CO₂ power source (sold separately)



30 ROUND RAPID PELLETT MAGAZINE



MINI RED DOT SIGHT (SOME MODELS)



VERTICAL FOREGRIP INCLUDED



AIR MCX™ SCOPE

- ▲ Simulated suppressor
- ▲ Optional scope combo with WHISKEY3™ ASP 4-12x44 scope
- ▲ Velocity up to 700 fps*



AIR MCX MRD

- ▲ Flip-up sights
- ▲ Optional sight combo with red dot sight
- ▲ Velocity up to 700 fps*

Available in FDE



AIR MCX

- ▲ Flip-up sights
- ▲ Velocity up to 700 fps*

Available in FDE



SIG RPM™ RAPID PELLETT MAGAZINE

The unparalleled performance of the SIG SAUER patented pellet drive system smoothly feeds up to 30 rounds in 3.5 seconds. Rifle comes standard with one magazine and refillable belt. Accessory RPM (purchased separately) includes three spare belts.

* Results may vary based on ammo weight, temperature, and altitude.

MCX	SKU	Caliber	Action Type	Operating System	Stock Type	Weight w/Mag (oz)	Overall Length (in)	Overall Height (in)	Barrel Length (in)	Construction	Velocity up to (FPS)	Mag Capacity	Sights / Optics
MCX SCOPE	AIR-MCX-SCOPE-177-88G-30-FDE	.177	Semi-Auto	CO ₂	Polymer	112	34.7	6.0	18.0	Metal / Poly	700	30	Whiskey ASP Scope (Combo Kit)
MCX MRD	AIR-MCX-MRD-177-88G-30-BLK / AIR-MCX-MRD 177-88G-30-FDE	.177	Semi-Auto	CO ₂	Polymer	112	34.7	6.0	18.0	Metal / Poly	700	30	Mini Red Dot Sight (Combo Kit)
MCX	AIR-MCX-177-88G-30-BLK / AIR-MCX-177-88G-30-FDE	.177	Semi-Auto	CO ₂	Polymer	112	34.7	8.8	18.0	Metal / Poly	700	30	Flip-up Sights

AIR MPX™ RIFLE



MAX MICHEL
Captain
TEAM SIG

SEMI-AUTOMATIC CO₂ AIR POWERED

Based on the original designs of the SIG SAUER® MPX, this CO₂ version is ideal for training and practice. Just like the SIG MPX® redefined the modern pistol caliber carbine, the SIG AIR® line of AIR MPX rifle redefines the CO₂ category of air rifles by delivering authentic SIG performance, handling, and rapid-fire capability.

.177CAL PELLETT

SHARED FEATURES

- ▲ Metal housing with polymer handguard and stock
- ▲ 30rd RPM pellet magazine
- ▲ Picatinny rail
- ▲ 90g CO₂ power source (sold separately)
- ▲ 8" rifled barrel



90g CO₂ power source (sold separately)



30 ROUND RAPID PELLETT MAGAZINE



MINI RED DOT SIGHT (SOME MODELS)



HAND STOP INCLUDED



AIR MPX™ MRD

- ▲ Includes a 20mm 20R Micro Red Dot Optic
- ▲ Flip up Front and Rear Sights
- ▲ Tactical Handstop
- ▲ Velocity Up to 575 fps*

Available in Black



SIG RPM™ RAPID PELLETT MAGAZINE

The unparalleled performance of the SIG SAUER patented pellet drive system smoothly feeds up to 30 rounds in 3.5 seconds. Rifle comes standard with one magazine and refillable belt. Accessory RPM (purchased separately) includes three spare belts.

* Results may vary based on ammo weight, temperature, and altitude.



AIR MPX

- ▲ Flip up Front and Rear Sights
- ▲ Tactical Handstop
- ▲ Velocity Up to 575 fps*

MPX	SKU	Caliber	Action Type	Operating System	Stock Type	Weight w/Mag (oz)	Overall Length (in)	Overall Height (in)	Barrel Length (in)	Construction	Velocity up to (FPS)	Mag Capacity	Sights / Optics
MPX	AIR-MPX-177-88G-30-BLK	.177	Semi-Auto	CO ₂	Polymer	99	25.7	6.0	8.0	Metal / Poly	498	30	Flip-Up Sights
MPX MRD	AIR-MPX-MRD-177-88G-30-FDE / AIR-MPX-MRD-177-88G-30-BLK	.177	Semi-Auto	CO ₂	Polymer	99	25.7	6.0	8.0	Metal / Poly	498	30	Mini Red Dot Sight

AIR PISTOLS



SEMI-AUTOMATIC CO₂ AIR POWERED

SIG AIR® Pistols are inspired by SIG SAUER centerfire pistols and designed with metal slides, rifled steel barrels, and the built-in performance advantages that are synonymous with SIG. With a SIG AIR Pistol, you have the ability to train anywhere, anytime.

.177CAL PELLETS

SHARED FEATURES

- ▲ Full blowback pistol
- ▲ Ambidextrous manual safety (M17™)
- ▲ Cam Lever CO₂ loading system
- ▲ Picatinny accessory rail



12g CO₂ power source (sold separately)

M17



AMBIDEXTRIOUS MANUAL SAFETY (M17)



CO₂ OR GREEN GAS COMPATIBLE



ADJUSTABLE REAR SIGHT (X-FIVE)



AIR M17®

- ▲ Optic ready slide
- ▲ Ambidextrous manual safety
- ▲ Velocity up to 430 fps*



SIG AIR reflex sight



Available in Black

AIR P320™

- ▲ Manual safety
- ▲ White dot sights
- ▲ Velocity up to 430 fps*



AIR P226™

- ▲ Cam lever CO₂ loading
- ▲ White dot sights
- ▲ Up to 480 fps*



AIR X-FIVE™

- ▲ 20rd RPM pellet magazine
- ▲ Adjustable rear sight
- ▲ Up to 430 fps*

BASED ON THE M17, THE OFFICIAL HANDGUN OF ALL BRANCHES OF THE U.S. MILITARY

* Results may vary based on ammo weight, temperature, and altitude.

AIR	SKU	Caliber	Mag Capacity	Length (in)	Height (in)	Width (in)	Barrel Length (in)	Weight w/Mag (oz)	Sights	Grip Type	Construction	Slide Finish
M17	AIR-M17-177	.177	20	8.0	6.5	1.3	4.0	5.0	White Dot / Mount Plate	Polymer	Metal / Poly	FDE
P320	AIR-P320-177-30R-CYT / AIR-P320-177-30R-BLK	.177	30	8.5	6.5	1.3	5.0	5.0	White Dot	Polymer	Metal / Poly	FDE / Black
P226	AIR-226F-177-12G-16-BLK	.177	18	8.0	5.2	1.5	4.5	3.9	White Dot	Polymer	Metal / Poly	Black
X-FIVE	AIR-X5-177-BLK	.177	20	9.0	6.5	1.5	4.6	4.6	White Dot	Polymer	Metal / Poly	Black

BB PISTOLS



SEMI-AUTOMATIC CO₂ POWERED

The SIG AIR® line of BB pistols feature CO₂-powered duplicates of the most desired SIG SAUER centerfire pistols in a 4.5mm BB platform for the ability to train anywhere, anytime.

4.5mm BB

SHARED FEATURES

- ▲ Full blowback metal pistol (Spartan, WTP)
- ▲ Blowback metal slide and polymer frame (P365)
- ▲ Ambidextrous manual safety
- ▲ 5" smooth bore barrel (Spartan, WTP)
- ▲ 3.5" smooth bore barrel (365™)



12g CO₂ power source (sold separately)



365™ BB

- ▲ 3.5" smooth bore barrel
- ▲ 3 DOT high visibility fixed sights
- ▲ SIG accessory rail
- ▲ Velocity up to 295 fps*



1911 SPARTAN BB

- ▲ 1913 accessory rail
- ▲ White dot sights
- ▲ Velocity up to 410*



1911 WE THE PEOPLE BB

- ▲ Distressed finish slide with 1776 Engraved on left, "We The People" engraved on right
- ▲ White dot sights
- ▲ Alloy star grips
- ▲ Velocity up to 410*



AMBIDEXTROUS MANUAL SAFETY (365)



"MOLON LABE" ON OIL-RUBBED BRONZE SLIDE



1776 ENGRAVED ON LEFT, WE THE PEOPLE ENGRAVED ON RIGHT, ALLOY STAR GRIPS

* Results may vary based on ammo weight, temperature, and altitude.

BB	SKU	Caliber	Mag Capacity	Length (in)	Height (in)	Width (in)	Barrel Length (in)	Weight w/Mag (lb)	Sights	Grip Type	Construction	Slide Finish
P365	AIR-P365-BB	w4.5 mm Steel BB	12	5.75	4.5	1.0	3.2	1.0	3 DOT High Visibility Fixed Sights	Polymer	Metal / Poly	Black
1911 SPARTAN	AIR-1911BB-SPARTAN	4.5 mm Steel BB	16	8.7	6.0	1.4	4.6	2.6	White Dot	Polymer	Metal	ORB
1911 WTP	AIR-1911WTP-BB	4.5 mm Steel BB	17	8.8	6.0	1.2	4.5	2.8	White Dot	Metal	Metal	Distressed

SIG AIR® ACCESSORIES

ENGINEERED TO A NEW STANDARD OF PERFORMANCE

REFLEX SIGHT

Designed for fast, responsive target acquisition with the M17™ / M18™ PROFORCE® and M17 pellet pistol with a 23mm field of view. Mounting plates included to quickly and easily upgrade your SIG AIR pistol.



SIG AIR reflex sight

HAND PUMP

The SIG AIR High-Pressure Hand Pump provides an affordable, reliable, and inexpensive method for filling your PCP airguns. For use with the 13 cu. in. tank on the SIG VIRTUS PCP rifle, but made to work with any brand of PCP gun with a male Foster quick-disconnect fitting. The 3-stage pump goes up to 4500 psi and includes an integral air pressure gauge.



PELLETS

PRECISION MEETS PERFORMANCE

SIG AIR® lead pellets offer a variety of shapes for all uses and differing levels of shooters. Options for shooting paper targets, or metal field targets and silhouettes, SIG AIR pellets will fit the needs and performance required for every shooter.



AIR CYLINDERS

PREMIUM AIRGUN PERFORMANCE

Available high quality, CO₂ cylinders and PCP air tank provide solid platforms for consistency and reliability. The use of SIG premium air cylinders for your SIG AIR products will ensure long lasting SIG performance.



90g CO₂ cylinder

12g CO₂ cylinder

Regulated 13ci high-pressure air cylinder

MAGAZINES

ELEVATE YOUR FIREPOWER

Utilizing a variety of different style magazines with innovative features, such as cam lever loading and the patented Rapid Pellet Magazine (RPM), SIG AIR magazines are engineered to elevate performance and firepower in all of your SIG AIR products.



30-round RPM™ magazine (Rapid Pellet Magazine)



P365 steel BB magazine

M17 20 round RPM magazine

SHOOTING TARGETS

Whether you are training in your garage, basement, or back yard, there is a SIG AIR Target to suit your training needs.



SIG SAUER ACADEMY



SIG SAUER ACADEMY



TRAIN WITH THE PROFESSIONALS



WE'LL MAKE YOU A BETTER SHOOTER. GUARANTEED.

With a team of world class instructors, from a broad range of backgrounds, the SIG SAUER Academy provides the finest firearms and tactics training available today. Using our objective and performance-based training methods, we can help develop and expand the abilities of virtually any level of firearms user.

Our expert staff of instructors has the unique ability and experience allowing them to train all types of firearms users, from civilians to law enforcement agencies, including elite military.

The SIG SAUER Academy is committed to delivering the best, most realistic, fundamentally sound training experience possible. We'll make you a better shooter. Guaranteed.

**FOR COURSE DESCRIPTIONS,
SCHEDULES, AND MORE, VISIT
SIGSAUERACADEMY.COM**

FACILITIES

The SIG SAUER AcademySM offers 140 acres of state-of-the-art indoor and outdoor training facilities. We have developed a variety of ranges and infrastructure allowing us to create almost any type of environment and to prepare for practically any situation. Facilities include:

- 26 Different Live Fire Ranges
- 1,000 Yard Rifle Range
- 2 Live Fire Shoot houses
- Indoor Pistol and Rifle Ranges
- 270 Degree Range
- Tactical Training with Breaching Capabilities
- Obstacle Course
- Vehicle Defense Range

Additionally, the SIG SAUER Academy is home to the factory-direct SIG SAUER Pro Shop, displaying the entire line of SIG SAUER pistols, rifles, electro-optics, suppressors, ammunition, airguns, accessories, and apparel.

PRIVATE AND MOBILE TRAINING

The SIG SAUER Academy is dedicated to providing the highest level of training available, tailored to fit any individual or organized group. We provide customized, private classes at our Academy, or we can take our expert training to a private location upon request.

Private classes for corporate and executive clients, government agencies and private groups, as well as for individuals, are available either as a standard course listed on our website or as a custom class designed to your specific needs. Private instruction ranges from foundational shooting tutorials to advanced dynamic tactics in a one-on-one or group learning environment.

INTERNATIONAL CUSTOMERS

The SIG SAUER Academy has a diverse staff of expert, bilingual instructors who provide the highest level of training and instruction to international civilian and military/law enforcement customers.

SIG SAUER Academy staff has consistently trained with some of the world's most elite counterterrorism units, providing expert instruction across a wide range of training needs. Our staff and facilities can provide any level of instruction needed to international clients, and can provide all of the necessary equipment and materials, including all tactical equipment and firearms, no matter what manufacturer or platform is required.

ABOUT OUR COURSES

PISTOL/RIFLE/SHOTGUN/PRECISION SCOPED RIFLE

The SIG SAUER Academy has programs that are designed to achieve results across a broad range of platforms, from pistols and rifles, to shotguns and precision long-range shooting. All courses are taught from a foundational level and have a progression structure allowing students to develop their skills at their own pace. Depending on your personal training objectives, we offer classes for personal and home defense, individual skill building, and instructor certification.



ADVANCED TRAINING

Advanced training courses are designed to take a student's skills to an extremely high level. These classes help provide students the knowledge, skills, and confidence to improve their performance and decision-making in a high-risk, high-stress environment. These courses include specific subjects such as low light pistol and rifle, advanced medical training, executive protection, as well as vehicle and scenario-based training.



ARMORER

SIG SAUER is one of the many major manufacturers which offers civilian armorer's courses. Our armorer's certification gives students a complete and thorough understanding of SIG SAUER firearms, including proper maintenance techniques, and inspection processes. These courses are designed to provide all of the necessary information to preserve the firearms factory warranty. Students who successfully complete these courses receive a three-year armorer certification.



LAW ENFORCEMENT/MILITARY

SIG SAUER Academy is dedicated to providing the highest level of global training for military and law enforcement professionals. Courses include specific subjects such as bus and vehicle assault, night vision, breaching, and direct threat care. Any course can be conducted remotely or customized to meet agency or department needs. Custom course design and implementation allow for any desired capability and duration of training. The SIG SAUER Academy also has physical fitness facilities available to visiting groups at no charge.



LEARN MORE AT SIGSAUERACADEMY.COM

SIG SAUER ACADEMY



MORE THAN TRAINING. A DESTINATION.

SIG SAUER ACADEMYSM is located in the Seacoast region of New Hampshire, just an hour north of Boston, and an hour south of Portland, Maine. New Hampshire is home to 18 miles of New England coastline and beaches, and is situated approximately an hour away from several top-rated ski resorts in the White Mountains. Nearby historic Portsmouth is a favorite tourist destination, featuring nationally-recognized restaurants and cuisine, outdoor sight-seeing activities, local boutiques, tax-free shopping, and a thriving nightlife. There are several major transportation hubs allowing easy access along with a wide variety of accommodations available nearby.

PRO SHOP

The SIG SAUER Academy Pro Shop is a full-service, factory-direct retail store open to the public, located on the grounds of the SIG SAUER Academy. The Pro Shop features the entire line of SIG SAUER pistols, rifles, electro-optics, suppressors, ammunition, airguns, accessories, and apparel and also has armorer's services available on-site. The Pro Shop staff are highly trained and can provide expert advice on all the latest SIG SAUER products.

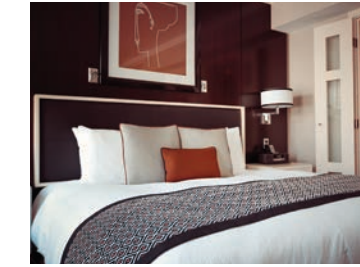

ACCOMMODATIONS

Through partnership with SIG SAUER®, we offer special rate arrangements with local hotels in Exeter, Dover, and Portsmouth NH, all within 10-30 minutes of the Academy.



TRANSPORTATION

The SIG SAUER Academy is approximately 30 minutes east of Manchester, New Hampshire Airport (MHT), and approximately an hour north of Boston International Airport (BOS) in Massachusetts. Some SIG SAUER partner hotels also offer students free shuttle access to and from the Academy.



EXETER

Boasting tree-lined streets and a wealth of historical architecture, Exeter is a quick 10 minutes from the Academy and hosts three of our preferred hotels. With ample restaurants, shopping and night life, this picturesque river town is a convenient place to stay while training at the Academy and is roughly 10 miles inland from the coast.



PORTSMOUTH

Venture into downtown Portsmouth, where you'll find a steady mix of modern and historic flair. From cobblestone-lined streets and historic buildings, to waterfront dining and local breweries, Portsmouth is not to be missed while here.

TEAM SIG



A TEAM OF THE HIGHEST CALIBER, COMMITTED TO EXCELLENCE

The mission of Team SIG is to support the development and production of the SIG SAUER® P320® pistol platform, the complete SIG SAUER rifle product line, SIG SAUER Electro-Optics, and SIG SAUER Ammunition. Team SIG works closely with the SIG SAUER engineers throughout the development and design of all SIG SAUER products to ensure every shooter enjoys the features that the Team SIG professional shooters demand.

ABOUT OUR SHOOTERS



MAX MICHEL - TEAM CAPTAIN

Max Michel, Jr. is one of the most dominant shooters in the world today and is recognized as a top-tier athlete and instructor. Max is a Guinness World Record holder and International Practical Shooting Confederation World Champion. He holds 8 World Speed Shooting Championships, 12 USPSA National Championships, 5 US Steel National Championships, is a 4-time Carry Optics National Champion, and holds more than 200 additional major championship victories. As an international competitor Max has represented the U.S.A. in the last seven IPSC World Shoots and returned home bearing gold each time and is set to compete once again in 2020 for Team U.S.A..

For Team SIG Max focuses primarily on carry optics competition, and as Team SIG Captain he serves as a mentor for Team SIG and is a premier brand ambassador for SIG SAUER®. Max is a U.S. Army Veteran.

Pistol: P320® XFIVE™
Optic: ROMEO1™ or ROMEO3MAX™
Ammo: Match Elite (9mm)



LENA MICULEK - PRO SHOOTER

Regarded as the top female 3-Gun competitor in the world, Lena dominates both 3-Gun and PCC competition. Lena entered into the competitive shooting world in 2005 with five consecutive Sportsman's Team Challenge Sub-junior and Junior Division national titles, and at 17 years old she won her first World Champion title. Since turning pro, Lena has earned more than 75 major wins including back-to-back NRA World Shoot "High Lady" titles, a "High Lady" title for carry optics, and 8 world titles. Additionally, in pistol caliber carbine (PCC) competition Lena is breaking barriers for female professional shooters. She is a two-time national female champion for PCC and was the first female to earn a top-five finish in PCC and was the first female to win Master Class for PCC.

For Team SIG Lena competes primarily in pistol caliber carbine (PCC) and 3-Gun competition.

Pistol: P320 XFIVE
Rifle: SIG MPX® PCC
Optic: ROMEO3™ and TANGO6T™
Ammo: Match Elite (9mm), Match (.223), Varmint (.223)



DANIEL HORNER - PRO SHOOTER

Daniel Horner is a multi-discipline World Champion shooter having captured over 125 championship titles at the world, national, regional, and state level. His titles include: 2019 All Army Champion, 10 USPSA Multi-Gun National Championships, 4 3-Gun National Championships, 2 International Sniper Competitions, 2 IDPA National Championships, an IPSC Shotgun National Championship, an NRA World Shooting Championship, and many more. Daniel is a U.S. Army Veteran and was recruited to the Army to join the U.S. Army Marksmanship Unit (USAMU), where he became one of the most decorated shooters in team history. He served as the Coach of the USAMU Action Shooting Team, and during his service was twice selected as the Military Marksmanship Association Soldier of the Year.

For Team SIG Daniel competes primarily in 3-gun and long-range rifle competition.

Pistol: P320 XFIVE with iron sights
Rifle: SIGM400®
Optic: TANGO6T™
Ammo: Match Elite (9mm), Match (.223), Varmint (.223)

PISTOL ACCESSORIES

P320® PRO-CUT SLIDES

Factory replacement PRO-CUT slide assembly for the P320 9mm.

- ▲ Optic ready with sight cover plate (ROME01PRO™ and DeltaPoint® Pro Footprint)
- ▲ XRAY3™ night sights
- ▲ Stylized relief cuts
- ▲ Available in black, coyote, and stainless finishes



P320 X-CHANGE KITS

The modular pistol has arrived. Removing P320 fire control group unlocks hundreds of combinations.

- ▲ Includes: complete slide, barrel, recoil spring assembly, grip module, and magazine
- ▲ Reflex optic compatible
- ▲ Not available for manual safety



P320 GRIP MODULES

Engineered to fit your hand and your P320.

- ▲ Full-sized, carry, compact, and sub-compact
- ▲ XFIVE; XFull, XCarry, XCompact
- ▲ Black, M17 coyote, and white
- ▲ Large, medium, and small (not available in all colors and XSERIES)
- ▲ XFIVE® grip module includes weight and magazine funnel



P320 TXG™ GRIP MODULE

The weight of steel and the flex of polymer

- ▲ Requires complete P320 fire control unit and XFIVE or full-size slide assembly
- ▲ Overall weight is 16.6oz
- ▲ Tungsten-infused polymer
- ▲ Available with extended magwell and internal weight
- ▲ Patent pending technology



Now you can purchase small parts for select SIG SAUER Firearms quickly and easily online at the SIG SAUER Webstore.

The SIG SAUER Small Parts Shopper is exclusive to sigsauer.com and intuitively navigates for upper or lower components of select SIG SAUER firearms so you can get the parts you need.

P320® AXG™ GRIP MODULE

Give your P320 a metal gun feel with the AXG Grip Module and customized grip panels/inserts.

- ▲ Alloy XSERIES grip
- ▲ Hogue G10 grip panels and inserts
- ▲ Hard anodized finish



PISTOL MAGAZINES

Original factory magazines designed specifically for SIG SAUER® pistols.

- ▲ Capacities from 6 to 21 Rounds
- ▲ .380 ACP, 9mm, .357 SIG, .40 S&W, 10mm, and .45 ACP



PISTOL BARRELS

SIG SAUER factory made pistol barrels.

- ▲ Offered in P238, P938, P210, P220, P226, P229, 1911, P320, and P365 firearms families
- ▲ Threaded and non-threaded versions



PISTOL TRIGGER UPGRADES

Introducing the next level in precision to Classic and P320 pistols.

- ▲ Made in Flat and Curved Trigger Configurations



PISTOL PART KITS

Keep your favorite firearm running like new.

- ▲ Replacement parts kits for classic, P320, and P365 models
- ▲ Factory approved parts for every need



RIFLE ACCESSORIES

SIG MCX® AR UPGRADE KIT

Transform any MIL-SPEC AR lower receiver into the adaptive and modular SIG MCX® VIRTUS.

- ▲ Complete SIG MCX Upper Receiver Assembly
- ▲ Lower receiver stock adapter
- ▲ Side-folding AR buffer tube knuckle
- ▲ Two-stage match duo trigger



SIG MCX RATTLER™ CONVERSION KIT

Convert any MIL-SPEC AR Lower into an MCX Rattler

- ▲ Complete SIG MCX Rattler upper receiver assembly
- ▲ Lower receiver stock adapter
- ▲ Side-folding AR Buffer tube knuckle
- ▲ Two-stage match duo trigger



SIG MCX VIRTUS® HANDGUARDS

Change the barrel and modify the Virtus handguard to match.

- ▲ PDW, carbine, rifle, and DMR lengths available
- ▲ Offered in black, FDE, and Virtus gray
- ▲ Suppressor adaptable configurations



SIG MCX & SIG MPX® STOCKS AND PCB BRACES

Options as diverse as your mission.

- ▲ M4 adjustable folding
- ▲ Dual-rod collapsible
- ▲ Skeletonized mini
- ▲ Skeletonized plus (not pictured)
- ▲ Pivoting contour brace
- ▲ Tele-stock (not pictured)



SIG MCX VIRTUS/RATTLER CALIBER EXCHANGE KIT

Move swiftly and easily between calibers and barrel lengths.

- ▲ 16" barrels (5.56 NATO/.300 BLK)
- ▲ 11.5" barrel (5.56 NATO)
- ▲ 9" barrels (.300 BLK)
- ▲ 6.75" barrels (.300 BLK)
- ▲ Rattler only 5.5" (.300 BLK / 5.56 NATO)



SIG MATCHLITE™ 2-STAGE TRIGGER

A trigger made for a SIG SAUER rifle, and perfect for any AR.

- ▲ Match grade performance
- ▲ Non-adjustable
- ▲ Includes hammer and trigger pins

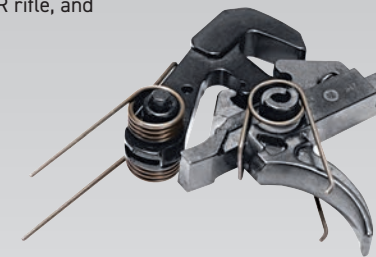

SIG MPX® CALIBER EXCHANGE KIT

Transition between barrel lengths efficiently.

- ▲ 16", 8", and 4.5" barrels (9mm)
- ▲ Available for Gen2 MPX only



SIG MPX HANDGUARDS

Configure the MPX for the barrel and the activity of your choice.

- ▲ K, PDW, and carbine lengths available
- ▲ Offered in black anodized

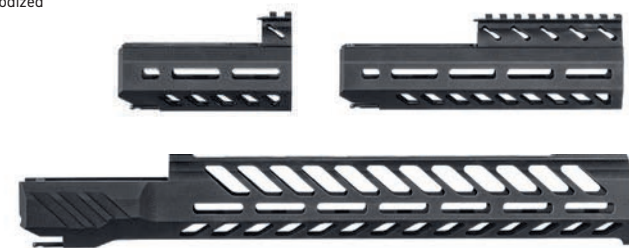

The TREAD® rifle is easily customizable with a full line of purpose-built accessories, designed in the U.S.A. Some items will fit most AR rifles.

SIG MATCHLITE 2-STAGE TRIGGER

Factory Upgrade Single Stage Trigger Kit for TREAD

- ▲ Match grade performance
- ▲ Non-adjustable
- ▲ Includes hammer and trigger pins



ROME05™ 1X20 MM

Robust, Compact Red Dot Sight

- ▲ 1x20 aiming solution for TREAD
- ▲ 2 MOA red-dot
- ▲ 10 illumination settings
- ▲ TREAD logo



3-CHAMBER COMPENSATOR

- ▲ Reduce Recoil and Muzzle Rise
- ▲ 5.56 mm, 1/2 x 28
- ▲ 7.62 mm, 5/8 x 24



AMBI CHARGING HANDLE

- ▲ Full ambidextrous design
- ▲ Medium-sized latches and dual roll pin
- ▲ Aircraft grade aluminum



M-LOK® HANDGUARDS

- ▲ Available in 10", 13", and 15" lengths
- ▲ M-LOK free float aluminum
- ▲ Two screw replacement



FLIP UP SIGHTS

Factory Replacement Sights Set for TREAD

- ▲ Tool-less adjustment
- ▲ Button-less flip-up and lock
- ▲ Includes sight rail



VERTICAL GRIP KIT

- ▲ M-LOK compatible
- ▲ Dual angle vert grip
- ▲ Includes barricade stop



M-LOK FORWARD GRIP KIT

- ▲ Vertical grip, barricade stop, handstop, long and short rail sections
- ▲ M-LOK compatible



*Visit sigsauer.com for additional items

SPEC1™

COMPLETE PREMIUM CARE SYSTEM

SIG SAUER® SPEC1, a premium firearm cleaning system. SPEC1 is a non-toxic, non-hazardous, pure synthetic-based lubricant with no Teflon®, silicones, or petroleum distillates. SPEC1 is formulated to reduce heat and wear, and to keep firearms running smoother and lasting longer. SPEC1 will not attract dust, dirt and sand, or feel sticky and tacky like most petroleum-based products on the market today. This synthetic lubricant will not dry up, freeze in cold temperatures, or allow carbon, copper, and plastic wad fouling to stick in the barrels or to gun parts. This non-toxic, non-hazardous formula is completely safe for the end user during application, cleaning, and firing.

PREMIUM BLEND

- ▲ Pure synthetic based lubricant with no Teflon™, silicones, or petroleum distillates
- ▲ Available in 2oz and 4oz bottles



PREMIUM BLEND GREASE

- ▲ Similar properties as the premium blend but in a grease for difficult service areas or areas that require grease.
- ▲ 100% synthetic



PREMIUM BLEND 30 HEAVY DUTY

- ▲ Pure synthetic based lubricant with no Teflon™, silicones, or petroleum distillates
- ▲ Available in 2oz and 4oz bottles
- ▲ 30 WT equivalent



SPEC1 PISTOL CLEANING KIT

- ▲ Premium components to aid in cleaning and to help prevent damage to your SIG SAUER pistol
- ▲ Pair this with your favorite SPEC1 lubricant to perform factory recommended cleaning
- ▲ Deluxe Kit includes: two-piece rod, aluminum CNC swivel rod handle, muzzle guard, bronze pistol brushes, pistol mops, brass jags, and patch holder for 9, .357, 40, and .45 cal pistol



PREMIUM CLEANING SYSTEM

- ▲ Premium bore solvent that removes carbon, lead, and plastic
- ▲ Premium firearm cleaner / degreaser
- ▲ Premium blend firearm lubricant



SIG MERCHANDISE

Show your SIG pride with a full line of SIG SAUER apparel, hats, and branded accessories. Choose from a wide range of sizes, men's or women's, and a variety of styles. There's something for everyone.

MITCH ROSEN™ LEATHER HOLSTERS

- ▲ Superior quality gunleather
- ▲ Professional level concealed carry
- ▲ Custom fit and function
- ▲ Handmade in the U.S.A.



BLACKPOINT™ TACTICAL HOLSTERS

- ▲ BlackPoint manufactured Kydex®
- ▲ Quality, comfort and conceal ability
- ▲ Built specifically for SIG pistols
- ▲ Made in the U.S.A.



BRANDED HATS

- ▲ SIG circle U.S.A. hat
- ▲ SIG Kryptek camo hat
- ▲ Flexfit® hats
- ▲ Snap back hats



AXIL TRACKR™ BLU ELECTRONIC BLUETOOTH EAR MUFFS

- ▲ Hearing enhancement, hearing protection, and 5.0 Bluetooth
- ▲ 40 dB gain/amplification
- ▲ Autolocker technology shuts off all sounds over 85 dB
- ▲ Sweat and water resistant



EYE PROTECTION

- ▲ SIG SAUER branded
- ▲ Clear polymer
- ▲ Adjustable arms
- ▲ Ballistic rated



APPAREL

- ▲ SIG SAUER T-Shirts
- ▲ Pullover hoodies
- ▲ Zipper pullovers
- ▲ Belts



KERSHAW® DROP POINT FOLDER

- ▲ Produced by Kershaw and co-branded SIG SAUER
- ▲ 14C28N Steel 3" Blade
- ▲ Pocket clip can be configured for tip-up or tip-down carry
- ▲ SpeedSafe® assisted flipper



PISTOL / RIFLE AMMUNITION



ELITE DEFENSE	V-CROWN	Caliber	Bullet Weight (grains)	Velocity in FPS MUZZLE 25 YDS 50 YDS 100 YDS	Energy in FT.-LBS MUZZLE 25 YDS 50 YDS 100 YDS	Trajectory in Inches 25 YDS 50 YDS 100 YDS	Product SKU
		380 AUTO	90	980 947 921 871	192 180 169 152	1.0 0.0 -9.8	E380A1-20
9MM LUGER (365)	115	1050 1008 972 912	282 259 241 212	0.8 0.0 -8.7	E9MMA1-365-20		
9MM LUGER +P	124	1198 1137 1086 1006	395 356 325 279	NA 0.0 -6.7	E9MMA2P-20		
9MM LUGER	115	1185 1126 1076 1000	359 324 296 255	0.6 0.0 -7.0	E9MMA1-20		
	124	1165 1102 1051 973	374 334 304 261	0.6 0.0 -7.3	E9MMA2-20		
	147	985 958 934 891	317 300 285 259	0.9 0.0 -9.5	E9MMA3-20		
357 SIG	125	1356 1271 1197 1080	511 449 398 324	0.4 0.0 -5.6	E357S1-20		
38 SUPER +P	125	1230 1156 1095 1004	420 371 333 280	0.6 0.0 -6.7	E38SU1-20		
38 SPL +P	125	900 876 853 810	225 213 202 183	1.2 0.0 -11.5	E38SP1-20		
357 MAG	125	1450 1346 1252 1106	584 503 435 340	0.3 0.0 -5.1	E357M1-20		
40 S&W	165	1090 1048 1013 954	435 403 376 334	0.7 0.0 -8.0	E40SW1-20		
	180	985 958 934 890	388 367 348 317	0.9 0.0 -9.4	E40SW2-20		
10MM AUTO	180	1250 1174 1111 1017	624 551 493 413	0.5 0.0 -6.5	E10MM1-20		
45 AUTO	185	995 953 917 855	407 373 345 300	0.9 0.0 -9.8	E45AP0-20		
	200	918 900 884 853	374 360 347 323	1.1 0.0 -10.6	E45AP1-20		
	230	830 810 791 755	352 335 319 291	1.4 0.0 -13.4	E45AP2-20		
44 S&W SPL	200	700 685 671 643	218 208 200 184	2.1 0.0 -18.8	E44SP1-20		
44 REM MAG	240	1300 1231 1171 1075	901 807 730 615	0.5 0.0 -5.8	E44MA1-20		
45 LONG COLT	230	850 829 809 771	369 351 334 304	1.3 0.0 -12.7	E45LC1-20		

MATCH	V-CROWN	Caliber	Bullet Weight (grains)	Velocity in FPS MUZZLE 25 YDS 50 YDS 100 YDS	Energy in FT.-LBS MUZZLE 25 YDS 50 YDS 100 YDS	Trajectory in Inches 25 YDS 50 YDS 100 YDS	Product SKU
		9MM LUGER	147	880 860 842 807	254 243 233 214	0.8 0.0 -11.4	E9MMA3-COMP-50

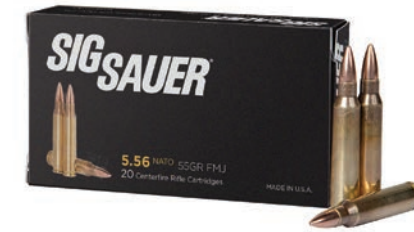

PISTOL	FMJ	Caliber	Bullet Weight (grains)	Velocity in FPS MUZZLE 25 YDS 50 YDS 100 YDS	Energy in FT.-LBS MUZZLE 25 YDS 50 YDS 100 YDS	Trajectory in Inches 25 YDS 50 YDS 100 YDS	Product SKU
		380 AUTO	100	910 879 859 800	184 172 161 142	1.2 0.0 -11.5	E380B1-50
9MM +P LEAD-FREE FRANGIBLE	90	1335 1210 1112 983	356 292 247 193	0.49 0.00 -6.51	E9MMLFF1-50		
9MM LUGER (365)	115	1050 1011 978 922	282 261 244 217	0.8 0.0 -8.6	E9MMB1-365-50		
9MM LUGER	115	1185 1125 1076 999	359 323 296 255	0.6 0.0 -7.0	E9MMB1-50		
	124	1165 1111 1065 993	374 340 312 272	0.6 0.0 -7.1	E9MMB2-50		
	147	985 960 936 895	317 301 286 261	0.9 0.0 -9.4	E9MMB3-50		
357 SIG	125	1356 1246 1154 1024	506 427 367 389	0.5 0.0 -6.0	E357B1-50		
38 SUPER +P	125	1230 1166 1111 1026	420 377 343 292	0.5 0.0 -6.5	E38SUB-50		
38 SPL	125	900 881 863 829	225 215 207 191	1.2 0.0 -11.2	E38SB1-50		
357 MAG	125	1450 1330 1225 1072	584 491 417 319	0.4 0.0 -5.3	E357MB-50		
40 S&W	180	985 959 935 893	388 367 349 319	0.9 0.0 -9.4	E40SB2-50		
10MM AUTO	180	1250 1185 1129 1042	624 561 510 434	0.5 0.0 -6.3	E10MB1-50		
45 AUTO	230	830 816 803 777	352 340 329 308	1.4 0.0 -12.9	E45BA3-50		

RIFLE	FMJ	Caliber	Bullet Weight (grains)	Velocity in FPS MUZZLE 100 YDS 200 YDS 300 YDS	Energy in FT.-LBS MUZZLE 100 YDS 200 YDS 300 YDS	Trajectory in Inches MUZZLE 100 YDS 200 YDS 300 YDS	Product SKU
		223 REM	55	3240 2875 2538 2225	1282 1009 787 605	0.0 -1.2 -7.9	E223B1-20
5.56 NATO	55	3273 2871 2503 2163	1308 1006 765 572	0.0 -1.3 -8.1	E556B1-20		
308 WIN	150	2900 2667 2447 2236	2801 2370 1993 1665	0.0 -1.9 -9.6	E308B1-20		
300 BLK	125	2145 1899 1672 1469	1277 1001 776 598	0.0 -6.7 -25.9	E300B1-20		

FURY	ACCUBOND	Caliber	Bullet Weight (grains)	Velocity in FPS MUZZLE 100 YDS 200 YDS 300 YDS 400 YDS 500 YDS	Energy in FT.-LBS MUZZLE 100 YDS 200 YDS 300 YDS 400 YDS 500 YDS	Trajectory in Inches MUZZLE 100 YDS 200 YDS 300 YDS 400 YDS 500 YDS	Product SKU
		277 FURY	150	2840 2656 2480 2311 2148 1991	2686 2350 2048 1778 1536 1321	0.0 -1.9 -9.5 -23.6 -45.3	H277SFAB150-20

RIFLE AMMUNITION



MARKSMAN	ELITE	Caliber	Bullet Weight (grains)	Bullet Type	Ballistic Coefficient (G1)	Velocity in FPS MUZZLE 100 YDS 200 YDS 300 YDS 400 YDS 500 YDS	Energy in FT.-LBS MUZZLE 100 YDS 200 YDS 300 YDS 400 YDS 500 YDS	Trajectory in Inches 100 YDS 200 YDS 300 YDS 400 YDS 500 YDS	Product SKU
		223 REM	77	OTM	0.362	2750 2499 2262 2038 1828 1633	1293 1068 875 710 571 456	0.0 -4.1 -15.0 -34.3 -64.1	E223M1-20
5.56 NATO	77	OTM	0.362	2750 2499 2262 2038 1828 1633	1293 1068 875 710 571 456	0.0 -4.1 -15.0 -34.3 -64.1	E556M4-20		
300 BLK	125	OTM	0.338	2200 1964 1752 1554 1379 1231	1343 1071 852 670 528 421	-0.0 -0.6 -23.4 -55.3 -105.5	E300A1-20		
300 BLK SUBSONIC	220	OTM	0.608	1000 968 940 915 892 870	488 458 432 409 389 370	-0.0 -355.5 -110.2 -226.5 -386.6	E300A2-20		
6 MM CREEDMOOR	107	OTM	0.527	2950 2771 2600 2434 2273 2118	2067 1824 1605 1407 1227 1066	0.0 -1.5 -8.2 -20.8 -40.1	E6MMCM2-20		
6.5 CREEDMOOR	140	OTM	0.535	2690 2524 2364 2209 2060 1918	2249 1980 1736 1517 1320 1143	0.0 -2.5 -11.2 -27.0 -51.0	E65CM1-20		
260 REM	140	OTM	0.526	2750 2579 2414 2255 2102 1955	2351 2067 1811 1580 1373 1188	0.0 -2.2 -10.4 -25.5 -48.4	E260M2-20		
308 WIN	168	OTM	0.462	2700 2505 2318 2138 1967 1805	2719 2340 2003 1705 1443 1215	0.0 -4.1 -14.6 -32.8 -59.9	E308M1-20		
	175		0.496	2600 2424 2256 2094 1939 1791	2626 2284 1977 1703 1460 1246	0.0 -2.9 -12.7 -30.4 -57.4	E308M2-20		
30-06	175	OTM	0.496	2700 2521 2348 2182 2023 1872	2832 2469 2142 1851 1591 1361	0.0 -2.5 -11.3 -27.4 -52.0	E3006M2-20		
300 WIN MAG	190	OTM	0.533	2850 2674 2505 2343 2186 2035	3426 3017 2648 2315 2016 1748	0.0 -3.4 -12.3 -27.5 -50.1	E3WMM1-20		

ELITE SERIES	TIPPED V&P	Caliber	Bullet Weight (grains)	Bullet Type	Ballistic Coefficient (G1)	Velocity in FPS MUZZLE 100 YDS 200 YDS 300 YDS	Energy in FT.-LBS MUZZLE 100 YDS 200 YDS 300 YDS	Trajectory in Inches 100 YDS 200 YDS 300 YDS	Product SKU
		223 REM	40	TIPPED	0.196	3650 3089 2570 2093	1183 847 587 389	0.0 -0.7 -6.7	E223V1-20
22-250 REM	40	TIPPED	0.196	3975 3390 2844 2346	1403 1021 718 489	0.0 -0.1 -4.5	E225V1-20		
243 WIN	55	TIPPED	0.225	3880 3377 2928 2496	1838 1393 1047 761	0.0 -0.1 -4.2	E243V1-20		
300 BLK SUBSONIC (9" BARREL)	205	TIPPED	0.445	1000 958 921 889	455 418 386 360	0.0 -34.9 -110.7	E300H2-20		

ELITE SERIES	ACCUBOND	Caliber	Bullet Weight (grains)	Bullet Type	Ballistic Coefficient (G1)	Velocity in FPS MUZZLE 100 YDS 200 YDS 300 YDS 400 YDS 500 YDS	Energy in FT.-LBS MUZZLE 100 YDS 200 YDS 300 YDS 400 YDS 500 YDS	Trajectory in Inches 100 YDS 200 YDS 300 YDS 400 YDS 500 YDS	Product SKU
		6.5 CREEDMOOR	140	ACCUBOND	0.509	2650 2477 2311 2150 1997 1850	2183 1907 1659 1437 1239 1064	0.0 -2.7 -11.9 -28.6 -54.1	E65CMAB140-20
308 WIN	65	ACCUBOND	0.475	2840 2647 2462 2284 2114 1951	2955 2567 2220 1912 1637 1395	0.0 -2.0 -9.7 -24.1 -46.3	E308AB165-20		
270 WIN	150	ACCUBOND	0.500	2860 2676 2499 2328 2165 2008	2724 2384 2079 1805 1560 1342	0.0 -1.9 -9.3 -23.2 -44.5	E270AB150-20		

RIFLE AMMUNITION



ELITE SERIES	COPPER	CALIBER	Bullet Weight (grains)	Bullet Type			Ballistic Coefficient (G1)	Velocity in FPS MUZZLE 100 YDS 200 YDS 300 YDS	Energy in FT.-LBS MUZZLE 100 YDS 200 YDS 300 YDS	Trajectory in Inches 100 YDS 200 YDS 300 YDS	Product SKU
		223 REM	60	HT				0.240	3100 2704 2340 2006	1280 974 730 536	0.0 -1.8 -10.0
300 BLK	120	HT				0.290	2250 1977 1726 1501	1349 10.42 794 600	0.0 -6.0 -23.6	E300H1-20	
243 WIN	80	HT				0.320	3425 3101 2801 2520	2083 1708 1393 1128	0.0 -0.6 -5.7	E243H1-20	
6MM CREEDMOOR	80	HT				0.340	3375 3073 2779 2499	2024 1678 1372 1109	0.0 -0.7 -5.9	E6MMCH1-20	
6.5 CREEDMOOR	120	HT				0.380	2825 2586 2359 2143	2126 1781 1482 1224	0.0 -2.2 -10.7	E65CH1-20	
308 WIN	150	HT				0.400	2900 2669 2449 2239	2801 2372 1997 1670	0.0 -1.9 -9.6	E308H1-20	
260 REM	120	HT				0.380	2880 2638 2408 2190	2210 1854 1545 1278	0.0 -2.0 -10.0	E260H1-20	
270 WIN	130	HT				0.380	3050 2798 2560 2335	2685 2260 1892 1573	0.0 -1.4 -8.2	E270H1-20	
30-06 SPRG	150	HT				0.400	2920 2649 2394 2153	2839 2337 1909 1544	0.0 -1.2 -10.0	E3006H1-20	
300 WIN MAG	165	HT				0.410	3110 2873 2649 2435	3543 3024 2570 2172	0.0 -1.2 -7.4	E3WMH1-20	



ELITE SERIES	TIPPED	CALIBER	Bullet Weight (grains)	Bullet Type			Ballistic Coefficient (G1)	Velocity in FPS MUZZLE 100 YDS 200 YDS 300 YDS 400 YDS 500 YDS	Energy in FT.-LBS MUZZLE 100 YDS 200 YDS 300 YDS 400 YDS 500 YDS	Trajectory in Inches 100 YDS 200 YDS 300 YDS 400 YDS 500 YDS	Product SKU
		243 WIN	90	Lead Core Tipped				0.490	3115 2916 2725 2543 2367 2199	1939 1699 1484 1292 1120 966	0.0 -1.1 -6.9 -18.0 -35.4
6 MM CREEDMOOR	100					0.515	2970 2786 2610 2441 2277 2120	1958 1724 1512 1322 1151 998	0.0 -1.5 -8.1 -20.5 -39.7	E6MMCTH2-20	
6.5 CREEDMOOR	130					0.510	2850 2670 2496 2329 2169 2015	2344 2057 1798 1566 1357 1171	0.0 -1.9 -9.4 -23.3 -44.5	E65CMTH1-20	
260 REM	130					0.510	2820 2641 2468 2303 2143 1990	2295 2013 1769 1530 1326 1143	0.0 -2.0 -9.7 -24.0 -45.8	E260TH1-20	
270 WIN	140					0.508	2950 2765 2587 2416 2252 2093	2705 2376 2080 1814 1576 1362	0.0 -1.6 -8.3 -21.0 -40.6	E270TH2-20	
7MM REM MAG	150					0.575	3000 2834 2674 2520 2371 2227	2997 2675 2381 2115 1872 1651	0.0 -1.3 -7.5 -19.2 -37.1	E7RMTH2-20	
308 WIN	165					0.530	2840 2667 2500 2339 2184 2035	2955 2605 2289 2004 1747 1517	0.0 -1.9 -9.4 -23.2 -44.3	E308TH2-20	
30-06 SPRG	165					0.530	2950 2772 2601 2437 2278 2126	3188 2815 2479 2175 1902 1655	0.0 -1.5 -8.2 -20.7 -40.0	E3006TH2-20	
300 WIN MAG	180					0.515	2960 2777 2601 2432 2269 2112	3501 3081 2703 2363 2057 1783	0.0 -1.5 -8.2 -20.7 -40.0	E3WMTH3-20	

ELECTRO-OPTICS SPECS

SIERRA6™ BDX

Model	Focal Place	Reticle	ADJ.	Exit Pupil MM		Linear Field of View				Eye Relief				Objective Filter Thread	Objective Clear Aperture		Weight		Elevation Adjustment Range	Windage Adjustment Range	Illumination Settings	Length	
				LOW	HIGH	FT @ 100 yards		M @ 100 M		INCH		MM			INCH	MM	OUNCE	GRAM				INCH	MM
						LOW	HIGH	LOW	HIGH	LOW	HIGH	LOW	HIGH		LOW	HIGH	LOW	HIGH				LOW	HIGH
2-12 x 40 mm	Second	BDX-R2 Digital Focal Plane OLED	.25 MOA	8.4	3.3	52.5	8.7	16.0	2.7	3.7	3.9	94	99	M 42 x 0.75	1.6	40	21.4	606	60 MOA	60 MOA	8 daytime/2 NV	10.75	273
3-18 x 44 mm	Second	BDX-R2 Digital Focal Plane OLED Ballistic w/ Side Focus	.25 MOA	8.2	2.4	34.9	5.8	10.6	1.8	3.7	3.9	94	99	M 46 X 0.75	1.7	44	23.8	674	60 MOA	60 MOA	8 daytime/2 NV	12.25	311
5-30 x 56 mm	Second	BDX-R2 Digital Focal Plane OLED Ballistic w/ Side Focus	.25 MOA	8.1	1.9	21.0	3.5	6.4	1.0	3.7	3.9	94	99	M 58 x 0.75	2.2	56	30.4	862	60 MOA	60 MOA	8 daytime/2 NV	14.75	375

SIERRA3™ BDX

Model	Focal Place	Reticle	ADJ.	Exit Pupil MM		Linear Field of View				Eye Relief				Objective Filter Thread	Objective Clear Aperture		Weight		Elevation Adjustment Range	Windage Adjustment Range	Illumination Settings	Length	
				LOW	HIGH	FT @ 100 yards		M @ 100 M		INCH		MM			INCH	MM	OUNCE	GRAM				INCH	MM
						LOW	HIGH	LOW	HIGH	LOW	HIGH	LOW	HIGH		LOW	HIGH	LOW	HIGH				LOW	HIGH
2.5-8 x 32 mm	Second	BDX-R1 Digital Focal Plane OLED Ballistic	.25 MOA	8.8	4.0	39.8	13.2	12.1	4.0	4.2	3.5	106.9	87.9	M 25.5 x 0.5	0.9	24	19.4	550	80 MOA	80 MOA	10 daytime/2 NV	12.75	324
3.5-10 x 42 mm	Second	BDX-R1 Digital Focal Plane OLED Ballistic	.25 MOA	8.8	4.2	27.8	9.4	8.47	2.9	4.2	3.5	106.9	87.9	M 25.5 x 0.5	0.9	24	20.9	593	55 MOA	55 MOA	10 daytime/2 NV	12.75	324
4.5-14 x 44 mm	Second	BDX-R1 Digital Focal Plane OLED Ballistic w/ Side Focus	.25 MOA	6.9	3.1	19.9	6.7	6.06	2.0	4.2	3.4	106.9	86	M 46 x 0.75	1.7	42	23.2	658	55 MOA	55 MOA	10 daytime/2 NV	12.6	320
4.5-14 x 50 mm	Second	BDX-R1 Digital Focal Plane OLED Ballistic w/ Side Focus	.25 MOA	8.9	3.6	19.9	6.7	6.06	2.0	3.6	4.2	85.1	106.9	M 46 X 0.75	1.8	44	24.9	706	55 MOA	55 MOA	10 daytime/2 NV	12.75	324
6.5-20 x 52 mm	Second	BDX-R1 Digital Focal Plane OLED Ballistic w/ Side Focus	.25 MOA	6.1	2.6	14.1	4.7	1.4	1.4	4.2	3.5	106.9	87.1	M 52 x 0.75	2.0	50	25.9	734	40 MOA	40 MOA	10 daytime/2 NV	14.25	362

KILOBDX™

Model	Magnification	Objective Clear Aperature	Exit Pupil MM	Eye Relief MM	Angular (FOV)	FOV@ 100 YDS	Range Response Time	Laser Divergence	Scanning	Range Resolution Under 100 YDS	Max Range			Weight with Battery		Length	
											REFLECTIVE	DEER	TREES	OZ	G	IN	MM
KILO3000™ BDX	10x	42 mm	4.2	18	6.1	32.0 ft	.25 sec	1.5 MRAD	yes	+/- 0.1 yds	Up to 5000 yds	Up to 2000 yds	Up to 4000 yds	32.0	907	5.2	145
KILO2400™ BDX	7x	25 mm	3.6	15	6.8	35.7 ft	.25 sec	1.4 MRAD	yes	+/- 0.1 yds	Up to 3400 yds	Up to 1400 yds	Up to 1800 yds	7.5	215	4.4	112
KILO2200™ BDX	7x	25 mm	3.6	15	6.8	35.7 ft	.25 sec	1.4 MRAD	yes	+/- 0.1 yds	Up to 3400 yds	Up to 1300 yds	Up to 1600 yds	7.5	215	4.4	112
KILO1800™ BDX	6x	22 mm	3.7	17	6.0	34.2 ft	.25 sec	1.3 MRAD	yes	+/- 0.1 yds	Up to 2000 yds	Up to 1000 yds	Up to 1200 yds	7.9	225	4.0	103
KILO1600™ BDX	6x	22 mm	3.7	17	6.0	34.2 ft	.25 sec	4.00 MRAD	yes	+/- 0.1 yds	Up to 2000 yds	Up to 1000 yds	Up to 1200 yds	6.4	180	4.3	109
KILO1000™ BDX	5x	20 mm	4.0	18	7.5	39.5 ft	.25 sec	2.00 MRAD	yes	+/- 0.1 yds	Up to 1200 yds	Up to 800 yds	Up to 1000 yds	5.2	147	4.3	109

KILO™

KILO2400ABS™	7x	25 mm	3.6	15	6.8	35.7 ft	.25 sec	1.4 MRAD	yes	+/- 0.1 yds	Up to 3400 yds	Up to 1400 yds	Up to 1800 yds	7.5	215	4.2	107
KILO1600™	6x	22 mm	3.7	17	6.0	34.1 ft	.25 sec	4.00 MRAD	yes	+/- 0.1 yds	Up to 2000 yds	Up to 1000 yds	Up to 1200 yds	6.4	180	4.3	109
KILO1000™	5x	20 mm	4.0	18	7.5	39.5 ft	.25 sec	2.00 MRAD	yes	+/- 0.1 yds	Up to 1200 yds	Up to 800 yds	Up to 1000 yds	5.2	147	4.3	109

ELECTRO-OPTICS SPECS

SIERRA® BDX 2.0™

KILO®

COMBO KITS	MAG	OBJECTIVE	RETICLE	ADJUSTMENTS	BATT	MAIN TUBE	LENGTH	WEIGHT	MAG	OBJECTIVE CLEAR APERTURE	EXIT PUPIL	EYE RELIEF	ANGULAR (FOV)	RANGE RESPONSE TIME	LASER DIVERGENCE	SCAN RATE	UNDER 100 YDS Resolution	MAX RANGE REFLECTIVE	MAX RANGE DEER	MAX RANGE TREES	WEIGHT
KILO2200BDX / SIERRA6BDX 3-18X44 SOK22BDX61	3-18	44	BDX-R2 Digital Focal Plane OLED Ballistic Side Focus	0.25 MOA	CR2031 (2)	30 mm	12.25"	23.8 oz	7x	25 mm	3.6 mm	15 mm	6.78°	0.25 sec	1.4 MRAD	4x Per Second	+/- 0.1 yds	Up To 3400 yds	Up To 1300 yds	Up To 1600 yds	7.5 oz / 212 g
KILO2400BDX / SIERRA6BDX 5-30X56 SOK24BDX61	5-30	56	BDX-R2 Digital Focal Plane OLED Ballistic Side Focus	0.25 MOA	CR2031 (2)	34 mm	14.75"	30.4 oz	7x	25 mm	3.6 mm	15 mm	6.78°	0.25 sec	1.4 MRAD	4x Per Second	+/- 0.1 yds	Up To 3400 yds	Up To 1400 yds	Up To 1800 yds	7.5 oz / 212 g
KILO1000BDX / SIERRA3BDX 2.5-8X32 SOK10BDX01	2.5-8	32	BDX-R1 OLED Ballistic	0.25 MOA	CR2031 (2)	30 mm	11.6"	19.4 oz	5x	20 mm	4.0 mm	18 mm	7.50°	0.25 sec	2.0 MRAD	4x Per Second	+/- 0.1 yds	Up To 1200 yds	Up To 800 yds	Up To 1000 yds	5.2 oz / 147 g
KILO1000BDX / SIERRA3BDX 3.5-10X42 SOK10BDX02	3.5-10	42	BDX-R1 OLED Ballistic	0.25 MOA	CR2031 (2)	30 mm	12.75"	20.9 oz	5x	20 mm	4.0 mm	18 mm	7.50°	0.25 sec	2.0 MRAD	4x Per Second	+/- 0.1 yds	Up To 1200 yds	Up To 800 yds	Up To 1000 yds	5.2 oz / 147 g
KILO1000BDX / SIERRA3BDX 4.5-14X44 SOK10BDX03	4.5-14	44	BDX-R1 OLED Ballistic Side Focus	0.25 MOA	CR2031 (2)	30 mm	12.60"	23.2 oz	5x	20 mm	4.0 mm	18 mm	7.50°	0.25 sec	2.0 MRAD	4x Per Second	+/- 0.1 yds	Up To 1200 yds	Up To 800 yds	Up To 1000 yds	5.2 oz / 147 g
KILO1600BDX / SIERRA3BDX 2.5-8X32 SOK16BDX01	2.5-8	32	BDX-R1 OLED Ballistic	0.25 MOA	CR2031 (2)	30 mm	11.6"	19.4 oz	6x	22 mm	3.7 mm	17 mm	6.0°	0.25 sec	4.0 MRAD	4x Per Second	+/- 0.1 yds	Up To 2000 yds	Up To 1000 yds	Up To 1200 yds	5.0 oz / 142 g
KILO1600BDX / SIERRA3BDX 3.5-10X42 SOK16BDX02	3.5-10	42	BDX-R1 OLED Ballistic	0.25 MOA	CR2031 (2)	30 mm	12.75"	20.9 oz	6x	22 mm	3.7 mm	17 mm	6.0°	0.25 sec	4.0 MRAD	4x Per Second	+/- 0.1 yds	Up To 2000 yds	Up To 1000 yds	Up To 1200 yds	6.4 oz / 181 g
KILO1600BDX / SIERRA3BDX 4.5-14X44 SOK16BDX03	4.5-14	44	BDX-R1 OLED Ballistic Side Focus	0.25 MOA	CR2031 (2)	30 mm	12.60"	23.2 oz	6x	22 mm	3.7 mm	17 mm	6.0°	0.25 sec	4.0 MRAD	4x Per Second	+/- 0.1 yds	Up To 2000 yds	Up To 1000 yds	Up To 1200 yds	6.4 oz / 181 g
KILO1600BDX / SIERRA3BDX 4.5-14X50 SOK16BDX04	4.5-14	50	BDX-R1 OLED Ballistic Side Focus	0.25 MOA	CR2031 (2)	30 mm	12.75"	24.9 oz	6x	22 mm	3.7 mm	17 mm	6.0°	0.25 sec	4.0 MRAD	4x Per Second	+/- 0.1 yds	Up To 2000 yds	Up To 1000 yds	Up To 1200 yds	6.4 oz / 181 g
KILO1600BDX / SIERRA3BDX 6.5-20X52 SOK16BDX05	6.5-20	52	BDX-R1 OLED Ballistic Side Focus	0.25 MOA	CR2031 (2)	30 mm	14.3"	25.9 oz	6x	22 mm	3.7 mm	17 mm	6.0°	0.25 sec	4.0 MRAD	4x Per Second	+/- 0.1 yds	Up To 2000 yds	Up To 1000 yds	Up To 1200 yds	6.4 oz / 181 g
KILO1800BDX / SIERRA3BDX 4.5-14X44 SOK18BDX01	4.5-14	44	BDX-R1 OLED Ballistic Side Focus	0.25 MOA	CR2031 (2)	30 mm	12.60"	23.2 oz	6x	22 mm	3.7 mm	17 mm	6.0°	0.25 sec	1.3 MRAD	4x Per Second	+/- 0.1 yds	Up To 2000 yds	Up To 1000 yds	Up To 1200 yds	7.9 oz / 224 g
KILO2200BDX / SIERRA3BDX 4.5-14X50 SOK22BDX01	4.5-14	50	BDX-R1 OLED Ballistic Side Focus	0.25 MOA	CR2031 (2)	30 mm	12.75"	24.9 oz	7x	25 mm	3.6 mm	15 mm	6.78°	0.25 sec	1.4 MRAD	4x Per Second	+/- 0.1 yds	Up To 3400 yds	Up To 1300 yds	Up To 1600 yds	7.5 oz / 212 g
KILO2400BDX / SIERRA3BDX 6.5-20X52 SOK24BDX01	6.5-20	52	BDX-R1 OLED Ballistic Side Focus	0.25 MOA	CR2031 (2)	30 mm	14.25"	25.9 oz	7x	25 mm	3.6 mm	15 mm	6.78°	0.25 sec	1.4 MRAD	4x Per Second	+/- 0.1 yds	Up To 3400 yds	Up To 1400 yds	Up To 1800 yds	7.5 oz / 212 g

TANGO6™

Model	Focal Place	Reticle	ADJ.	Exit Pupil MM		Linear Field of View				Eye Relief				Objective Filter Thread	Objective Clear Aperture		Weight		Elevation Adjustment Range	Windage Adjustment Range	Illumination Settings	Length	
				LOW	HIGH	FT @ 100 yards		M @ 100 M		INCH		MM			INCH	MM	OUNCE	GRAM				INCH	MM
						LOW	HIGH	LOW	HIGH	LOW	HIGH	LOW	HIGH		LOW	HIGH							
1-6X24 mm	First	5.56MM / 7.62MM Horseshoe Dot	0.2 MOA	11.4	4.0	105.8	17.7	35.3	5.9	3.93	4.09	100	104	M 25.5 x 0.6	0.9	24	22.0	626	106.5 MOA 31 MRAD	106.5 MOA 31 MRAD	9 Daylight/ 2 NV	10.8	275
		DWLR6	0.2 MOA																			106.9	35.6
1-6X24 mm	Second	FL-6 HELLFIRE®	0.2 MOA	11.4	4.0	105.8	17.7	35.3	5.9	3.93	4.09	100	104	M 25.5 x 0.6	0.9	24	22.0	626	106.5 MOA 31 MRAD	106.5 MOA 31 MRAD	9 Daylight/ 2 NV	10.8	275
		MOA MILLING HELLFIRE	0.5 MOA																			106.9	35.6

TANGO6™

5-30 x 56 mm	First	MOA DEV-L	0.25 MOA	8.9	1.9	18.9	3.3	6.3	1.1	3.6	3.5	92	89	M 58 x 0.75	2.2	56	42	1191	80 MOA 23.2 MRAD	50 MOA 14.5 MRAD	7 Daytime/ 2 NV	14.38	365
		MRAD DEV-L	0.1 MRAD																			14.38	365

TANGO4™

1-4X24 mm	First	5.56/7.62 Horseshoe Dot	0.5 MOA	15.4	6.1	98	24	32.7	8	3.3	3.3	84	84	M 46 x 0.75	0.9	24	15.9	450	180 MOA 52 MRAD	180 MOA 52 MRAD	8 Daylight/ 2 NV	10.0	275																	
4-16X44 mm	First			10.6	2.7	24.1	6.3	6.3	24.1	3.3	3.3	84	84	M 46 x 0.75	0.9	24	20.5	581	90 MOA 26 MRAD	80 MOA 23 MRAD	8 Daylight/ 2 NV	13.6	345																	
		MOA Milling	0.25 MOA																			13.6	345																	
6-25X50 mm	First	DEV-L MOA	0.25 MOA	8	2.1	14.7	3.7	5.3	1.4	3.3	3.3	84	84	M 52 x 0.75	2.0	50	22.9	649	60 MOA 17 MRAD	30 MOA 8.5 MRAD	8 Daylight/ 2 NV	15.6	307.2																	
		DEV-L MRAD	0.1 MRAD																			15.6	307.2																	
		MOA Milling	0.25 MOA																			15.6	307.2																	
		MRAD Milling	0.1 MRAD																			15.6	307.2																	

ELECTRO-OPTICS SPECS

WHISKEY3™

Model	Focal Place	Reticle	ADJ.	Exit Pupil		Linear Field of View				Eye Relief				Objective Clear Aperture		Weight		Elevation Adjustment Range		Windage Adjustment Range		Length	
				MM	MM	FT @ 100 yards		M @ 100 M		INCH		MM		INCH	MM	OUNCE	GRAM	INCH	MM	INCH	MM		
						LOW	HIGH	LOW	HIGH	LOW	HIGH	LOW	HIGH										
2-7 X 32 mm	Second	Quadplex	0.25 MOA	10.6	4	47.1	13.75	15.7	4.5	3.6	3.6	88.9	88.9	1.2	32	14.3	405	90	90	11.5	292		
		BDC-1 Quadplex																					
3-9 X 40 mm	Second	Quadplex		13.3	4.4	35	11.89	11.7	4					1.6	40	15.3	434	80	80	12.4	315		
		Hellfire Quadplex																					
		BDC-1 Quadplex																					
3-9 X 50 mm	Second	Quadplex		16.6	2.9	35	11.89	11.7	4					1.9	50	18.1	513	80	80	12.6	320		
		Hellfire Quadplex																					
		BDC-1 Quadplex																					
4-12 X 40 mm	Second	Quadplex		10	3.5	24.8	8.27	8.24	2.74					1.6	40	16.6	470	60	60	12.5	318		
		Hellfire Quadplex																					
		BDC-1 Quadplex																					
4-12 X 50 mm	Second	Quadplex		12.5	2.1	24.8	8.27	8.24	2.74					2	50	17.5	500	60	60	12.6	322		
		Hellfire Quadplex																					
		BDC-1 Quadplex																					

BRAVO™

Model	Magnification	Field of View	Eye Relief	Prism Coating	Illumination	Motion Sensor	Waterproof	Weight		Length		Width		Height	
								OZ	G	IN	MM	IN	MM	IN	MM
BRAVO5™	5x	6°	60 mm	Dielectric	11 Settings, RED	Yes, MOTAC, 2 Min Auto-Off	IPX-7	23	652	6.4	163.3	2.6	65.4	2.9	75
BROVO3™	3x	10°	60 mm	Dielectric	11 Settings, RED	Yes, MOTAC, 2 Min Auto-Off	IPX-7	22	624	6.4	163.3	2.6	65.4	2.9	75
BROVO4™	4x	7.5°	60 mm	Dielectric	10 Settings, RED	Yes, MOTAC, 2 Min Auto-Off	IPX-8	21.2	601	5.8	147	2.5	63	2.9	75

ECHO™

Model	Magnification	Eye Relief	Field of View	Frame Rate	Runtime	Color / Contrast Settings	Close Focus Distance	Spectral Response	Digital Elevation Adjustment Range	Weight		Length		Width		Height	
										OZ	G	IN	MM	IN	MM	IN	MM
ECHO3™	1-6x23mm / 2-12x40mm	Unlimited	10° / 5.8°	30Hz	6 hrs	8 Color Paletts	3 ft	9-14 um, 320x240-12 um VOx LWIR Core	150 MOA x 150 MOA	14.5 / 16.6	411 / 471	4.1 / 4.7	104 / 120	2.6	66	3.1 / 3.6	79 / 92

FOXTROT™

Model	Led Output	Operating Mode	Runtime	Weight		Length		Width		Height	
				OZ	G	IN	MM	IN	MM	IN	MM
FOXTROT365™	100 + Lumens	Instant Activation	1 Hour	1.3	37	3.8	96.5	1.0	25.4	1.9	48.3
FOXTROT1™	100 / 200 / 300 Lumens	Momentary or Latching	2 Hours	3.0	84	3.1	79.0	1.2	30.4	1.2	30.4
FOXTROT1X™	450 Lumens	Momentary or Latching	1.5 Hours	1.9	54	2.4	61.5	1.2	30.4	1.3	33
FOXTROT2™	550 Lumens	Programmable with Momentary, Latching, and Threshold	1.5 Hours	1.9	54	2.6	65	1.2	30.4	1.3	33

JULIET™

Model	Magnification	Field of View	Clear Aperture	Exit Pupil	Eye Relief	Diopter Range	Adjustment Range	Weight		Length		Width		Height	
								OZ	G	IN	MM	IN	MM	IN	MM
JULIET6™	6x	4°	24 mm	4 mm	59 mm	+/- 2	+/- 30 MOA	14.7	416	5.4	137.16	1.95	49.3	2.9	73.6
JULIET4™	4x	6.25°	24 mm	6 mm	65 mm	+/- 2	+/- 45 MOA	12.5	257	4.2	107	2.1	53	2.6	66
JULIET3™	3x	8°	24 mm	8 mm	65 mm	+/- 2	+/- 55 MOA	12.5	257	4.2	107	2.0	71	2.8	70
JULIET3-MICRO™	3x	6.8°	22 mm	5.7 mm	63 mm	+/-2	+/- 50 MOA	9.9	281	3.2	81	2.7	69	2.4	61

LIMA™

Model	Laser	Operating Mode	Run Time		Adjustment	Spot Size	Weight		Length		Width		Height	
			Red	Green			OZ	G	IN	MM	IN	MM	IN	MM
LIMA1™	Class 3R Red or Green	Momentary or Continuous	> 5 Hours	> 2 Hours	Windage + Elevation	.5 @ 50 ft	1.6	45	2.0	51	1.2	31	0.85	22
LIMA320™	Class 3R Red or Green	Instant Activation	> 5 Hours	> 3 Hours	Windage + Elevation	.5 @ 50 ft	4.0	113.4	7.1	180.5	1.32	33.6	4.2	106.3
LIMA365™	Class 3R Red or Green	Instant Activation	> 4 Hours	> 2 Hours	Windage + Elevation	.5 @ 50 ft	1.3	37	3.8	96.5	1.0	25.4	1.9	48.3

ELECTRO-OPTICS SPECS

ROMEO™

Model	Magnification	Eye Relief	Objective Clear Aperature	Red Dot Size	Illumination Settings	Elevation Adjustment Range	Windage Adjustment Range	Weight		length		width		height	
								oz	G	IN	MM	IN	MM	IN	MM
ROMEOZero™	1x	Unlimited	24 mm	3 MOA / 6 MOA	8 Daytime	50 MOA	50 MOA	.4	14	1.6	40.8	.93	23.7	.93	28.7
ROMEO1PRO™	1x	Unlimited	30 mm	3 MOA / 6 MOA	10 Daytime / 2 NV	100 MOA	100 MOA	1.0	28	1.8	46.5	1.2	31.7	1.1	27.4
ROMEO1™	1x	Unlimited	30 mm	3 MOA / 6 MOA	8 Daytime / 2 NV	100 MOA	100 MOA	.8	24	1.8	44.9	1.3	32.8	1.1	27.4
ROMEO2™	1x	Unlimited	30 mm	3 MOA / 6 MOA	12 Daytime / 3 NV	120 MOA	120 MOA	1.6	45	1.8	45.7	1.3	33	1.1	28
ROMEO3™	1x	Unlimited	25 mm	3 MOA	9 Daytime	100 MOA	100 MOA	1.4	40	2.4	60	1.1	28	1.65	42
ROMEO3XL™	1x	Unlimited	35 mm	3 MOA / 6 MOA	10 Daytime / 2 NV	80 MOA	80 MOA	1.5	43	2.0	54	1.41	36	1.4	35
ROMEO3MAX™	1x	Unlimited	30 mm	3 MOA / 6 MOA	10 Daytime / 2 NV	80 MOA	80 MOA	1.5	43	2.0	54	1.29	33	1.4	35
ROMEO4T™	1x	Unlimited	20 mm	2 MOA / 1 MOA	10 Daytime / 2 NV	100 MOA	100 MOA	3.2	91	3.3	84.6	1.86	47.85	2.46	62.6
ROMEO4DR™	1x	Unlimited	20 mm	2 MOA	10 Daytime / 2 NV	100 MOA	100 MOA	7.6	215	3.4	86	1.82	46.2	2.5	63.5
ROMEO4S™	1x	Unlimited	20 mm	2 MOA / 1 MOA	10 Daytime / 2 NV	100 MOA	100 MOA	7.6	215	3.4	85.6	1.8	46	2.5	63.5
ROMEO4H™	1x	Unlimited	20 mm	2 MOA	10 Daytime / 2 NV	100 MOA	100 MOA	7.6	215	3.4	86	1.82	46.2	2.5	63.5
ROMEO5XDR™	1x	Unlimited	20 mm	2 MOA	8 Daytime / 2 NV	+/- 40 MOA	+/- 40 MOA	5.6	159	2.5	63.5	1.4	35.6	2.6	66
ROMEO5X™	1x	Unlimited	20 mm	2 MOA	8 Daytime / 2 NV	100 MOA	100 MOA	5.6	159	2.5	63.5	1.4	35.6	2.6	66
ROMEO5 TREAD™	1x	Unlimited	20 mm	2 MOA	8 Daytime / 2 NV	100 MOA	100 MOA	5.1	145	2.5	62.7	1.5	38.1	1.5	38.6
ROMEO5™	1x	Unlimited	20 mm	2 MOA	8 Daytime / 2 NV	+/- 60 MOA	+/- 60 MOA	4.8	136	2.9	75	1.6	41	1.4	36
ROMEO7™	1x	Unlimited	30 mm	2 MOA	9 Daytime / 2 NV	100 MOA	100 MOA	12.5	356	4.8	120	2	51	3	76.2
ROMEO7S™	1x	Unlimited	22 mm	2 MOA	9 Daytime / 2 NV	100 MOA	100 MOA	7.7	219	3.2	81	2.1	53	2.6	66

ROMEO™

Model	Magnification	Eye Relief	Objective Clear Aperature	Red Dot Size	Illumination Settings	Elevation Adjustment Range	Windage Adjustment Range	Weight		length		width		height	
								oz	G	IN	MM	IN	MM	IN	MM
ROMEO8T™	1x	Unlimited	38 mm	2 MOA	10 Daytime / 2 NV	+/- 70 MOA	+/- 70 MOA	13.7	388	3.5	89.4	1.97	50	2.8	71
ROMEO8H™	1x	Unlimited	38 mm	2 MOA	10 Daytime / 2 NV	+/- 70 MOA	+/- 70 MOA	10.3	292	3.5	89.4	1.97	50	2.8	71
ROMEO-MSR™	1x	Unlimited	20 mm	2 MOA	10 Daytime / 2 NV	100 MOA	100 MOA	4.9	139	3.1	79	1.5	38	2.6	66

OSCAR™

Model	Magnification	Exit Pupil	Clear Aperature	Close Focus Distance	Eye Relief	Linear FOV M at 1000 Yards	Linear FOV M at 1000 M	Angular FOV	Waterproof Level @ 1 M Eye Piece Attached	Weight		Length		Width		Height	
										oz	G	IN	MM	IN	MM	IN	MM
OSCAR8™	27-50 x 80	2.96 mm / 1.45 mm	80 mm	5 m	17-16 mm	105-73 ft	35-24 m	2° - 1.4°	5 min	68	1928	15.27	388	4.0	102	6.11	155
OSCAR3™	10-20 x 30	3.0 mm / 1.5 mm	30 mm	6 m	23-15 mm	179-126 ft	54.6-38.4 m	3.4° / 2.4°	5 min	16	454	6.7	170.2	1.9	48	2.9	74

XRAY™

Model	Housing	Illumination	Front Sight	Rear Sight	Sight Picture
X-RAY3™	Steel	Tritium	High Contrast Green Outline	Subtle Black Outline	3 Dot

ZULU™

Model	Magnification	Exit Pupil	Clear Aperature	Close Focus Distance	Interpupillary Distance	Diopter Range	Eye Relief	Linear FOV FT @ 1000 Yards	Linear FOV M @ 1000 M	Angular FOV	Weight		Length	
											oz	G	IN	MM
ZULU9™	11 X 45	4.1 mm	45 mm	6 ft	56 mm - 74 mm	+/- 3	16.7 mm	315 ft	105 m	6.0°	33	950	7.5	190.5
	15 X 56	3.8 mm	56 mm	9 ft	56 mm - 79 mm	+/- 3	17.8 mm	236 ft	78.7 m	4.5°	43	1220	7.5	190.5
ZULU7™	10 x 42	4.2 mm	42 mm	5.9 ft	56 mm - 74 mm	+/- 3	17 mm	341 ft	114 m	6.5°	33	950	5.8	147.3
ZULU5™	10 x 42	4.2 mm	42 mm	8.2 ft	56 mm - 74 mm	+/- 3	15 mm	315 ft	105 m	6.0°	24.5	694.5	6.0	152.4
ZULU6™	10 x 30	3 mm	30 mm	11.5 ft	56 mm - 78 mm	+/- 3	15 mm	273 ft	91.01 m	5.2°	18.6	528	5.9	150
	16 x 42	2.62 mm	42 mm	13.1 ft	56 mm - 78 mm	+/- 3	14 mm	199 ft	66.42 m	3.8°	20	568	7.1	180

SIG AIR® SPECS

SIG AIR PISTOLS

Model	Caliber / Mag Cap.			Velocity (up to)		Measurements (in)				Weight (lb)	Operating System	Construction	Sights
	.177 cal	.22 cal	6.0 mm	FPS	FPE	Length	Height	Width	Barrel Length				
M17	20			430	3.0	8.0	6.5	1.3	5.0	2.15	CO2	Metal / Poly	White Dot
P365™ BB	12			295	0.07	5.75	4.5	1.0	3.2	1.0	CO2	Metal / Poly	3 DOT High Visibility Fixed Sights
WTP BB			17	410	2.0	8.8	6.0	1.2	4.6	2.8	CO2	Metal	White Dot
1911 BB			16	410	2.0	8.7	6.0	1.4	4.6	2.6	CO2	Metal	White Dot
XFIVE™	20			430	3.0	9.0	6.5	1.5	4.6	3.0	CO2	Metal	White Dot
P226™	16			480	4.0	8.0	5.2	1.5	3.9	2.6	CO2	Metal	White Dot
P320™	30			310	2.0	7.9	5.6	1.3	5.0	1.7	CO2	Metal / Poly	White Dot
M17™ PROFORCE®			21	410 / 320	0.07 / 0.05	8.5	6.5	1.3	5.0	2.25	CO2 / GG	Metal / Poly	White Dot / Mount Plate
M18™ PROFORCE			21	410 / 320	0.07 / 0.05	7.5	6.5	1.3	4.0	2.0	CO2 / GG	Metal / Poly	White Dot / Mount Plate
P229™ PROFORCE			23	295	0.04	7.5	5.2	1.25	4.5	2.5	GG	Metal / Poly	White Dot

SIG AIR® SPECS

SIG AIR RIFLES

Model	Caliber / Mag Cap.			Velocity (up to)		Measurements (in)				Weight (lb)	Operating System	Construction	Sights / Optics			
	.177 cal	.22 cal	6.0 mm	FPS .177/ .22 CAL	FPE .177/ .22 CAL	Length	Height	Width	Barrel Length				Flip-Up	20mm SIG 20R Red Dot Optic	1-4 x24 Scope	WHISKEY ASP Scope
ASP20™	1	1		1020 / 840	20/23	45.5	6.0	1.5	14.0	8.5 lb	Gas Piston	Steel and Wood / Syn Stock				•
VIRTUS™		30		700	12	37.5	9.0	2.3	18.0	7.5 lb	Pre-Charged PNeumatic	Metal / Poly	•			
MCX™	30			700	5.71	34.7	8.8	1.5	18.0	7.0 lb	CO2	Metal / Poly	•	•	•	
MPX™	30			575	3.86	25.7	8.5	1.3	8.0	6.0 lb	CO2	Metal / Poly	•	•		
MCX PROFORCE			120	375	0.06	29.0	9.0	1.5	11.5	7.0 lb	Automatic Electric Gun	Metal				

RIFLE SPECS

Rifle Models	Caliber	Action Type	Operating System	Stock Type	Forend Type	Weight w/o Mag	Overall Length	Collapsed Length	Folded Length	Barrel Length	Rifling	Trigger Type	Mag Type	Mag Capacity
SIG MCX VIRTUS														
SIG MCX VIRTUS PATROL	5.56 NATO	Semi-Auto	Gas Piston, Rotating Bolt	Tele/Fold 5-Position	Free-Float M-LOK*	7.9 lb	35.5"	N/A	26.5"	16.0"	1:7	2-Stage Match	AR-15 Type	30
PMCX with PCB 11.5"	5.56 NATO	Semi-Auto	Gas Piston, Rotating Bolt	Fixed Folding PCB	Free-Float M-LOK	7.4 lb	31.0"	N/A	22.0"	11.5"	1:7	2-Stage Match	AR-15 Type	30
PMCX with PCB 9"	300 BLK	Semi-Auto	Gas Piston, Rotating Bolt	Fixed Folding PCB	Free-Float M-LOK	7.0 lb	28.5"	N/A	19.5"	9.0"	1:5	2-Stage Match	AR-15 Type	30
SIG MCX RATTLER														
SIG MCX RATTLER SBR	300 BLK	Semi-Auto	Gas Piston, Rotating Bolt	Fixed Folding	Free-Float M-LOK	5.7 lb	23.5"	N/A	16"	5.5"	1:5	2-Stage Match	AR-15 Type	30
SIG MCX RATTLER SBR	5.56 NATO	Semi-Auto	Gas Piston, Rotating Bolt	Fixed Folding	Free-Float M-LOK	5.7 lb	23.5"	N/A	16"	5.5"	1:7	2-Stage Match	AR-15 Type	30
SIG MCX RATTLER PCB	300 BLK	Semi-Auto	Gas Piston, Rotating Bolt	Fixed Folding PCB	Free-Float M-LOK	5.7 lb	23.5"	N/A	16"	5.5"	1:5	2-Stage Match	AR-15 Type	30
SIG MCX RATTLER PCB	5.56 NATO	Semi-Auto	Gas Piston, Rotating Bolt	Fixed Folding PCB	Free-Float M-LOK	5.7 lb	23.5"	N/A	16"	5.5"	1:7	2-Stage Match	AR-15 Type	30
SIG MCX RATTLER CANEBRAKE	300 BLK	Semi-Auto	Gas Piston, Rotating Bolt	Fixed Folding PCB	Free-Float M-LOK	6.8 lb	29.0"	N/A	21"	5.5"	1:5	2-Stage Match	AR-15 Type	30
SIG MPX														
SIG MPX PCC	9MM	Semi-Auto	Gas Piston, Rotating Bolt	Tele/Fold 5-Position	Free-Float M-LOK	6.6 lb	35.0"	N/A	25.0"	16.0"	1:10	Single Stage Timney	MPX	30
SIG MPX K PCB	9MM	Semi-Auto	Gas Piston, Rotating Bolt	Fixed Folding PCB	Free-Float M-LOK	6.0 lb	22.5"	N/A	13.5"	4.5"	1:10	Single Stage Timney	MPX	30
SIG MPX COPPERHEAD PCB	9MM	Semi-Auto	Gas Piston, Rotating Bolt	Telescoping PCB	N/A	4.5 lb	14.5"	N/A	N/A	3.5"	1:10	MIL-SPEC	MPX	20
SIG MPX COPPERHEAD K PCB	9MM	Semi-Auto	Gas Piston, Rotating Bolt	Telescoping PCB	N/A	4.8 lb	15.5"	N/A	N/A	4.5"	1:10	Single Stage Timney	MPX	30
SIGM400														
SIGM400 TREAD	5.56 NATO	Semi-Auto	Direct Gas Impingement	6-Position Telescoping	Free-Float M-LOK	7.0 lb	36.5"	N/A	N/A	16.0"	1:8	Hardened Polished	AR-15 Type	30
SIGM400 TREAD PISTOL	5.56 NATO	Semi-Auto	Direct Gas Impingement	Telescoping Brace	Free-Float M-LOK	6.5 lb	32.0"	N/A	N/A	11.5"	1:7	Hardened Polished	AR-15 Type	30
SIG716G2														
SIG716 TREAD	7.62 NATO	Semi-Auto	Direct Gas Impingement	6-Position Telescoping	Free-Float M-LOK	8.5 lb	37.0"	33.8"	N/A	16.0"	1:10	Hardened Polished	SR25 Type	20
CROSS BOLT RIFLE														
CROSS BOLT	6.5 CM	Bolt Action	NA	SIG Precision Stock	Free-Float M-LOK	6.4 lb	38.5"	36.5"	27"	18"	1:9	2-Stage Match	AICS	5
CROSS BOLT	308 WIN 277 FURY	Bolt Action	NA	SIG Precision Stock	Free-Float M-LOK	6.2 lb	36.5"	34.5"	25"	16"	1:10 /1:8.5	2-Stage Match	AICS	5



SIG SAUER, Inc. • 72 Pease Boulevard • Newington, NH 03801 USA • +1 (603) 610-3000

An ISO 9001:2015 Registered Company. Manufacturing in the U.S.A.

sigsauer.com